



Decisions about Special Seats and Wheelchairs

CHAPTER 64

In this chapter we look at the things you will need to consider when buying or building a special seat or wheelchair, to best meet the needs of a child. *Adaptations* of seats and wheelchairs for special *positioning* needs are discussed in Chapter 65. Designs for building 6 basic wheelchairs are in Chapter 66.

Meeting the needs of the individual child, family, and community

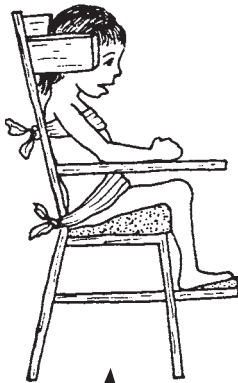
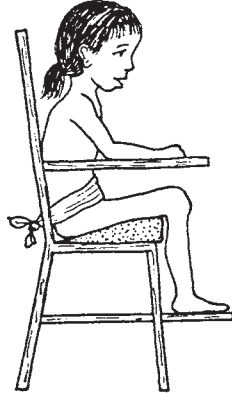
Most children who need a wheelchair or special seat have severe weakness in parts of their bodies, or *muscles* that pull them into awkward or deforming positions. Seating should, as much as possible, keep these children in **healthy and useful** positions. It must **provide support**, but also **allow them enough freedom** to move, explore, and develop greater control of their bodies. For example:

1. A child who is 'floppy' and slow to develop ability to sit, 
2. may at first need a seat with straps and supports to hold her up. 
3. As she develops better head control and then body control, the supports can be removed little by little, 
4. until finally—if possible—she is able to sit anywhere, with little or no special supports. Now low back support is all she needs. 

CP

CAUTION: If a child needs to be supported as much as the one in the second picture, **do not keep her strapped in her seat for long**. She also needs periods of free movement and exercise to develop more independent head and body control. Keeping her strapped in for too long, or providing too much support after she has begun to gain more control, may actually slow down her progress. **Seating needs to be changed and supports reduced as the child develops.**

Also, children who do not feel in their *butts* need frequent position changes and 'lifting' (see p. 198), and special cushions (see p. 200).

Special seats and wheelchairs need to be adapted not only to the individual child, **but also to the particular family, local customs, and community situation.** For example:

A **'high chair'** lets the child join the family that eats at a table.

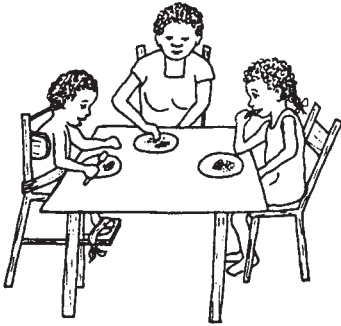

A **'low chair'** lets the child fit in where the family eats at ground level.



Also, a **'high' wheelchair** may be helpful where cooking and other activities are done high up.

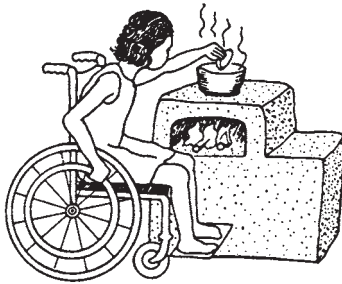

But a low **'wheelboard' or 'trolley'** may be better where cooking and other activities are done at ground level.



It is also important to consider the type of ground surface on which a wheelchair will be used.

Where land is flat and fairly smooth, and entrance into houses is level, a **chair with a small wheel at the rear** may work well and be less costly to make.



But where there are curbs, steps, rocks, or other obstacles, a chair with small wheels at the front works better.

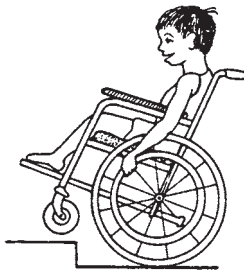

To jump over obstacles, the child can learn to do a **'wheely'** (tilt the chair back with the front wheels in the air).

On rough, sandy surfaces **wide back tires** and relatively large, wide front casters make moving about much easier.

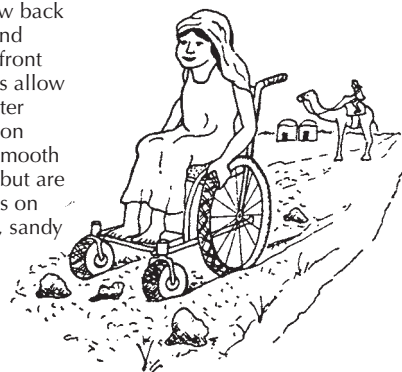

Wide tires, like the wide feet of a camel, help in sandy places.

Having the right wheelchair for the local situation frees the child to move about more easily in the community.

Healthy, comfortable, and functional positions

Whether or not a chair has wheels, **the position in which it allows a child to sit is very important.** (See Chapter 65.)

For most children, the chair should help them to sit more or less like this:

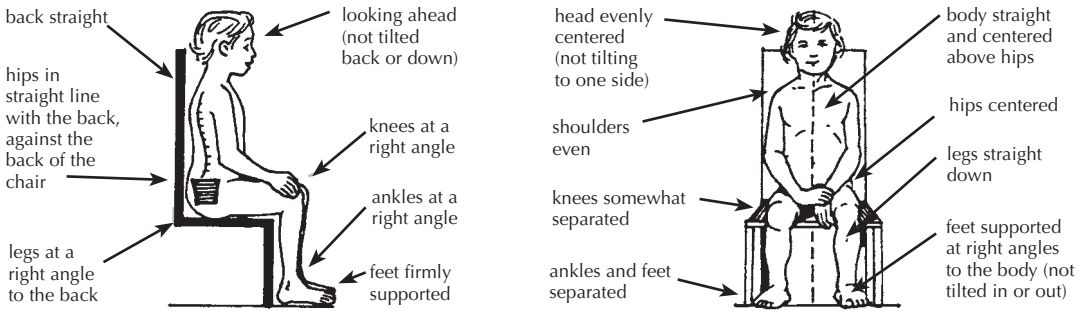

CAUTION: The seat should be wide enough to allow some free movement and narrow enough to give needed support (see Measurements, p. 602).

Common seating problems and possible solutions

Problem: **Hips tilt back**



In children with spastic cerebral palsy the hips often stiffen backward. This triggers spasms that straighten the legs and cause other muscle tightness with loss of control.



Also, children with weak hips or back, from *spinal cord* injury, spina bifida, or severe polio, often sit slumped with their hips tilted back and the back severely curved. This can lead to permanent deformity.

One of the most common causes of backward tilting hips is **a chair like this one that is too big** for the child.

CP

Other causes of backward tilt and bad position are:

a chair back that tilts far back

and a cloth back that sags.

These let the child lean back and cause the hips to slip forward.



Also, footrests that are far forward so that knees do not bend enough can increase *spasticity* that tilts hips back

A good position can often be gained through:

a fairly stiff, upright back at a right angle to the seat.

a chair that fits the child so that his hips reach the chair back.



the knees at right angles, and feet firmly supported.

BETTER

Most children, and especially a child who tends to fall forward in his seat, will sit better and more comfortably if the whole chair tilts back a little. But be sure to keep right angles at hips, knees, and ankles.



To tilt the chair back, the rear wheel mount can be moved higher **up**. You may also need to move the wheel mount **back** farther to keep the chair from falling backward when going uphill. Be sure the front caster barrel is still straight up or making turns will be harder.



Keeping cost down and quality up

For many families, a wheelchair can be a great or even impossible expense. There are many ways to keep costs down. But be careful. Some low-cost choices may make the chair too clumsy, weak, or unsafe. Other low-cost choices may actually increase the chair's usefulness and life. For example, a very useful, long-lasting wheelchair can be made of wood—or from a cheap wooden chair. Even wheels made of wood (if made well) may work well and last a long time. But, making the hubs or bearings of wood usually leads to trouble. Standard wheelchair wheel bearings are very expensive. However you can often get strong, high-quality, used metal bearings free or very cheap at electrical appliance repair shops or auto repair shops.

Factory-made or homemade wheelchairs?

Often you can save money by making your own wheelchair or by asking a local craftsman to make one. Also, a homemade chair design can be more easily adapted to your child's particular needs.

On the next pages we give information that may help you decide about different wheelchairs and effective low-cost ways to make them.

You can make a fairly effective low-cost wheelchair by attaching bicycle wheels or wooden wheels to an ordinary wooden chair. Also, it is easier to attach special aids or supports to a wooden chair than to a metal chair. This design is adapted from Healthlink Worldwide's booklet, "Personal Transport for Disabled People" (see p. 604).

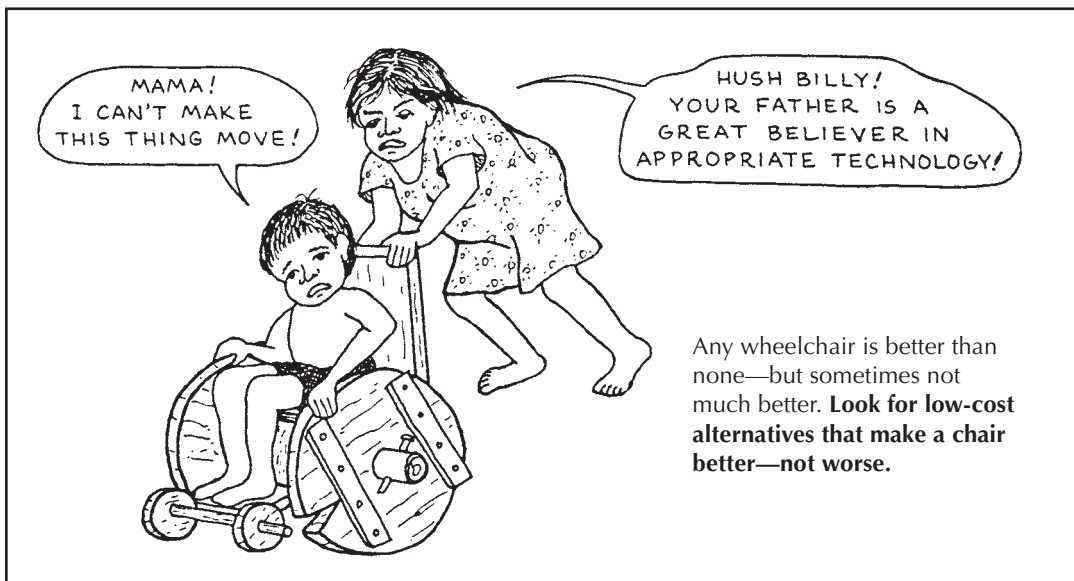
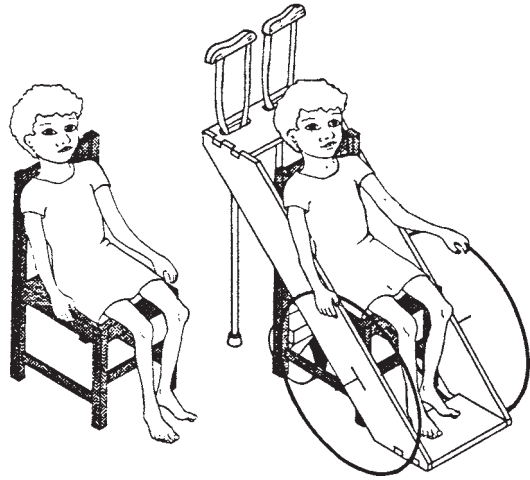

REMEMBER: A wheelchair needs to satisfy the rider—not just the maker. Before (and after) buying or making a chair, think carefully about the different features that will help it best meet the needs of the particular child and family.



When buying or making a wheelchair (or any other aids), consider:





- **Cost.** Keep **cost low** but **quality high** enough to meet the child's needs (see p. 592).
- **How long will the chair last?** The longer the better, unless it is only for temporary use.
- **How easy and quick is it to make?** The easier and quicker the better, as long as it meets your needs.
- **Availability of materials.** Make use of local low-cost, good-quality resources (local wood, cheap metal, used bearings, bike parts, etc.).
- **What tools and skills are needed to make it?** If welding equipment or skills are not locally available, a wooden chair may be a more practical choice.
- **How easy will it be to adjust or repair?** Wood chairs that are bolted together are often the easiest to adjust or add special supports to.
- **Weight.** The lighter the better, while making sure it is strong enough.
- **Strength.** Heavier persons need stronger chairs and stronger axles. (A small child's chair may be supported by a bicycle axle attached on one side only. A bigger child needs the axle to be supported on both sides, or a stronger axle. See p. 598 and 615.)
- **Width and length.** The narrower and shorter the better while meeting the child's needs (but not so short that it tips over easily).
- **How easily can it be moved**—by the child sitting in it or by someone behind? **How easily can it be tilted back** to go over rough spots? **Lifted** up stairs? **Transported?** (Does it need to **fold** to take up less space?)
- **How well is it adapted to the particular child's wants and needs?** Is it comfortable? Does it allow the child to sit in a healthy position?
- **Fit and growth factor.** How well does it fit the child now? How long will it continue to fit her? Can it be adjusted to fit her as she grows?
- **How well is it adapted to living situations,** the **home,** local **customs,** width of **doorways,** surface of **floors** and **roads,** curbs and other barriers?
- **Appearance.** Is the chair attractive? Does the child take pride in it? Do other children want to ride it?

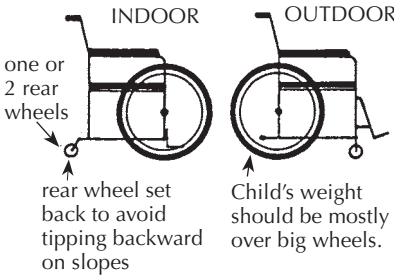

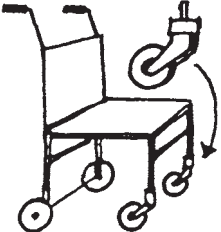
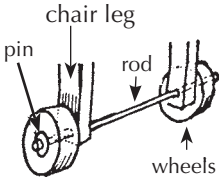
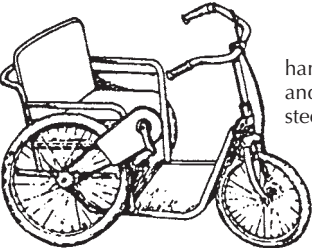
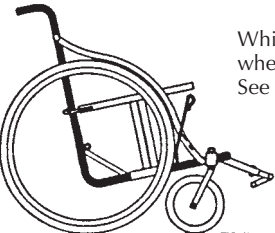
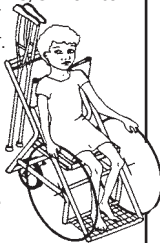
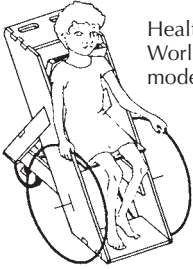
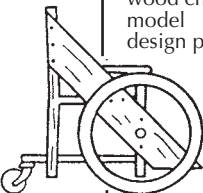

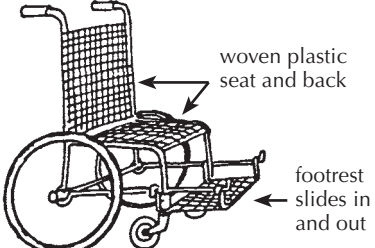
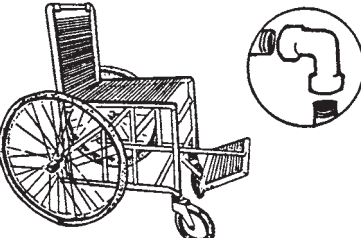
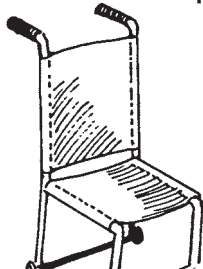

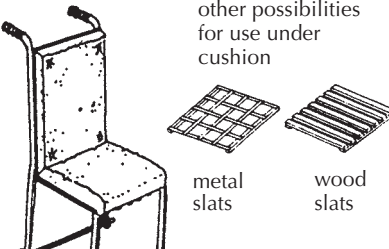

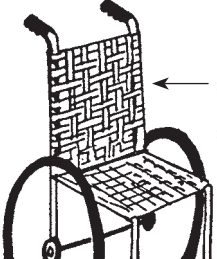



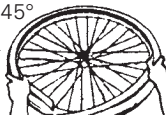

In considering choices for the design, building materials, and special features of a wheelchair, be sure to carefully consider the above questions.

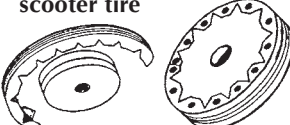
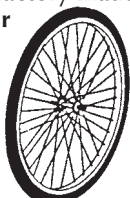
Design choices for wheelchairs

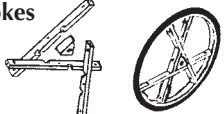

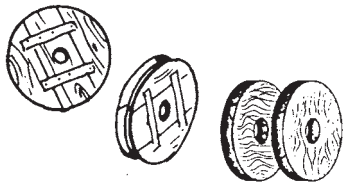
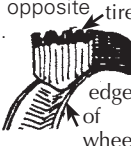
FEATURE	DESIGN DETAILS	ADVANTAGES	DISADVANTAGES
<p>WHEEL SIZE AND POSITION</p> <p>2 big wheels with 1 or 2 small caster wheels</p>  <p>INDOOR OUTDOOR</p> <p>one or 2 rear wheels</p> <p>rear wheel set back to avoid tipping backward on slopes</p> <p>Child's weight should be mostly over big wheels.</p>	<ul style="list-style-type: none"> • Large wheels let rider push herself. • Small caster wheels allow easy turns (on cement, not sand). • For leg amputees, rear wheels must be moved back to prevent tipping over backward. 	<ul style="list-style-type: none"> • Child can move it herself if she has hand and arm control. • Large wheels go over rough surfaces easier. 	<ul style="list-style-type: none"> • takes up more space • harder to get in and out of from the side (because wheels need to be higher than seat so that rider can push herself)
<p>4 small wheels</p>  <p>casters for easier turning</p>	<p>Very simple temporary chairs can be made by putting 4 wheels on an ordinary wood chair.</p>  <p>chair leg</p> <p>pin rod wheels</p>	<ul style="list-style-type: none"> • good only on smooth floors for a child who cannot push or help push his own chair • cheaper • takes up less space • easier to move child in and out of. 	<ul style="list-style-type: none"> • not good on rough surfaces • Child cannot move it herself. • creates dependency
<p>3 big wheels</p>  <p>hand crank and steering</p>	<ul style="list-style-type: none"> • You can use 3 bicycle wheels. • Some models have removable front wheels so that chair can be easily changed to have small front wheels for use inside the home. 	<ul style="list-style-type: none"> • excellent for long distance and rough road travel • can be used by a person with strength in one hand only <div data-bbox="901 1176 1248 1265" style="border: 1px solid black; padding: 5px;"> <p>Some riders have 2 chairs: one like this for road travel, and a smaller one for home or work.</p> </div>	<ul style="list-style-type: none"> • too big for use inside home • more costly • more difficult to make
<p>BUILDING MATERIAL FOR FRAME</p> <p>Steel tube</p>  <p>Whirlwind wheelchair See p. 622.</p>	<ul style="list-style-type: none"> • Thin-walled electrical conduit tubing can be used—5/8 inch to 1 inch diameter.  <p>Healthlink Worldwide design, see p. 604.</p>	<p>A strong, long-lasting, fairly light chair can be made better and cheaper than most commercial chairs.</p>	<ul style="list-style-type: none"> • requires welding skills, some design ability, and a fair amount of equipment • a good chair for a well-equipped rehabilitation center workshop to build, but not a family • builders need to be trained
<p>Wood</p>  <p>Healthlink Worldwide model</p>	<p>For wood design details, see p. 615 and 620 and references on p. 604.</p> <p>wood chair model design p. 615</p> 	<ul style="list-style-type: none"> • relatively cheap and easy to make—mostly wood, few or no welds • easy to adapt and to add special supports or tray tables <p>plywood model design p. 620</p>	<ul style="list-style-type: none"> • May not be as stable and long-lasting as other models. <p>(For tighter joints and more adaptability, use nuts and bolts instead of nails.)</p>

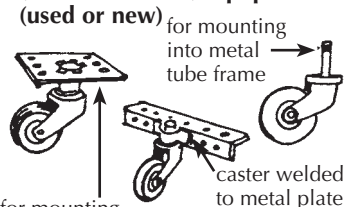

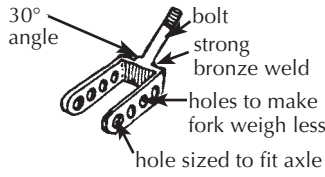
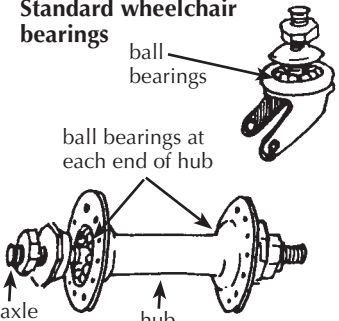
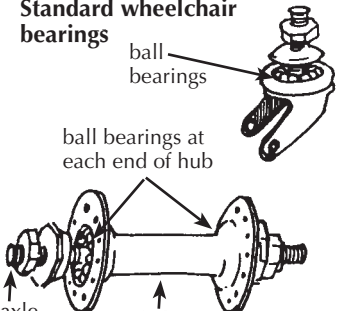
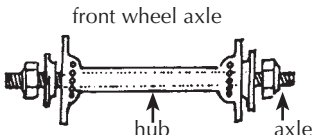
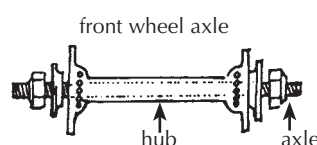

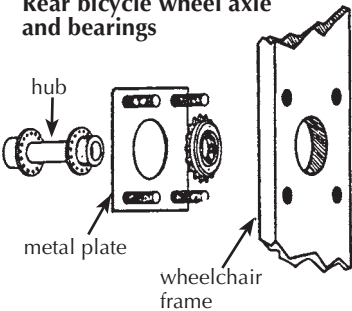
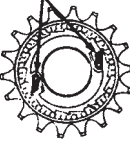
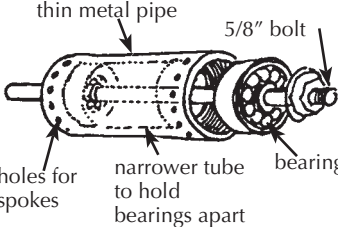
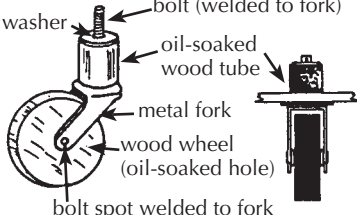
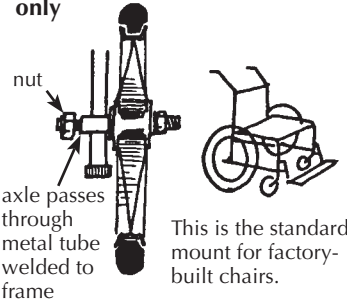
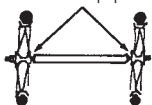
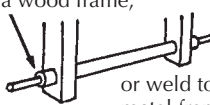
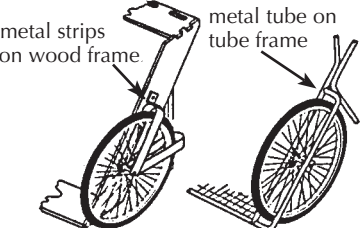
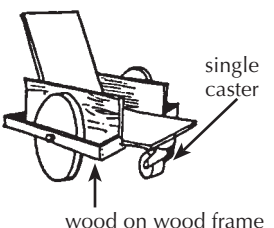
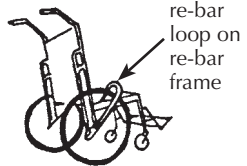
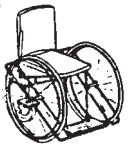

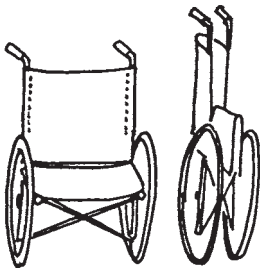
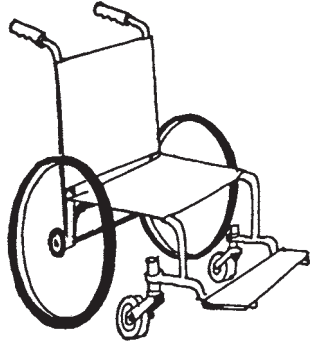
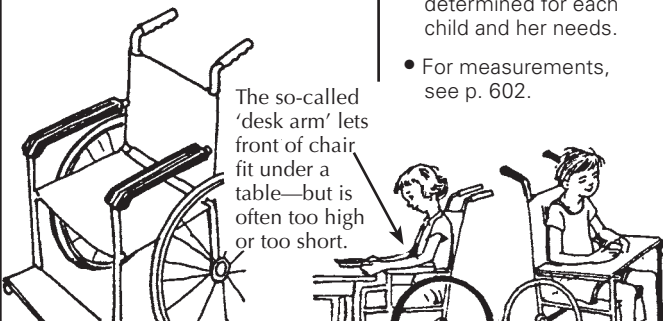
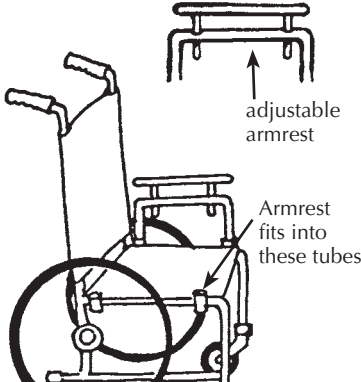





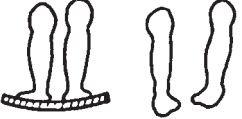

FEATURE	DESIGN DETAILS	ADVANTAGES	DISADVANTAGES
<p>Re-bar (metal reinforcing rod used to strengthen cement)</p> 	<p>Design can be the same as for metal tube chairs, but it is easier to adapt because the re-bar is easy to bend.</p>	<ul style="list-style-type: none"> • relatively cheap • easier to bend and weld than steel tubing • can have plastic woven seat and back (easy to clean) • especially good for small chairs 	<ul style="list-style-type: none"> • A heavy person or rough treatment may bend it out of shape. • fairly heavy
<p>PVC pipe (plastic water pipe)</p> 	<ul style="list-style-type: none"> • Use 15 mm. PVC pipe. • comes with joints so that it can be fitted together with a special glue • For details see reference, p. 606. 	<ul style="list-style-type: none"> • lightweight • can be built mostly by glueing pieces together 	<ul style="list-style-type: none"> • costly materials (around \$100 US) • Plastic tubing will in time sag or bend in the direction of stress. <p>Therefore it may be necessary to fiberglass the frame—which adds to cost, work, and weight.</p>
<p>SEATS AND BACKS Soft canvas or leather stretched between supports</p> 	<ul style="list-style-type: none"> • For child who is likely to pee or shit in the chair, use a cloth that is easy to wash. • Plastic-coated canvas makes cleaning easy but is hot and may irritate child's bottom. Best to use an absorbent washable pad over it. 	<ul style="list-style-type: none"> • easiest seating and back design for folding wheelchairs • Adjustment to shape of butt gives comfort (but cushion is needed to protect against pressure sores). • Curving back may help keep child from falling sideways. 	 <ul style="list-style-type: none"> • Soft, curving back lets child bend in an unhealthy position (see p. 591). • hard to attach positioning aids • In children with spasticity or muscle imbalance, this may increase the risk of developing knock-knee <i>contractures</i>.
<p>Firm (but padded) back and seat</p>  <p>other possibilities for use under cushion</p> <p>metal slats wood slats</p>	<ul style="list-style-type: none"> • Use wood or thin plywood. • Special designs allow a wood seat to swing up for folding. 	<ul style="list-style-type: none"> • Wood seat and back allow easy addition of supports and adaptations. • Firm wood back and seat help child sit with back straight and knees apart (especially important for children with spasticity). 	<ul style="list-style-type: none"> • may be less comfortable • without cushion may cause pressure sores in child with no feeling in his butt • heavier • difficult or impossible to fold the chair
<p>Woven seat and back</p>  <p>strips of old inner tube stretched tight</p>	<ul style="list-style-type: none"> • Use natural basket fibers, reeds, or rattan, • or use plastic webbing, • or use tightly stretched strips of car inner tube. 	<ul style="list-style-type: none"> • An open weave is cooler in hot weather. • Plastic or rubber woven seats can be easily washed. Can be used as a chair to bathe in. 	<ul style="list-style-type: none"> • must be kept stretched tight; not useful on folding chairs • may not last long if material is not strong • same sag problems as with canvas or leather

FEATURE	DESIGN DETAILS	ADVANTAGES	DISADVANTAGES
<p>TIRES Pump-up with air 'balloon' tires</p> 	<ul style="list-style-type: none"> • Bicycle tires and tubes work well for the large wheels—20 inch (51 cm.), 24 inch (61 cm.), or 26 inch (66 cm), wide or narrow. • Puncture-proof inner liners may be available. 	<ul style="list-style-type: none"> • softer ride • easy to replace • wide tires good for sand and rough ground • narrow tires better on smooth, paved roads 	<ul style="list-style-type: none"> • Puncture (hole in tire) may occur— especially on rough roads. • more costly than some other tires • wears out sooner than solid tires
<p>Solid tires (standard wheelchair wheels)</p> 	<p>Buy from wheelchair supply center to fit diameter and width of rim.</p>	<ul style="list-style-type: none"> • no flat tires • good for speed on very smooth surfaces 	<ul style="list-style-type: none"> • costly • hard to replace • very hard, bumpy ride on rough surfaces • very narrow—sinks into sand
<p>Rubber hose inside bicycle tire</p> 	<ul style="list-style-type: none"> • Overlap ends and cut at 45° angle • Fit hose into tire. 	<ul style="list-style-type: none"> • no flat tires • softer ride than with solid tire • cheap 	<ul style="list-style-type: none"> • Flattening of tire where it touches ground means it moves slower, and is harder to push.
<p>Thin strip of old car tire</p> 	<ul style="list-style-type: none"> • Cut strip in wedge shape to fit rim. • Wire ends together 	<ul style="list-style-type: none"> • no cost • long-lasting • Wire ends together. • Sink bolt head, and/or bolt the ends. 	<ul style="list-style-type: none"> • bumpy ride • difficult to fit well on rim and to fasten ends firmly
<p>Large machinery fanbelt (discarded)</p> 	<ul style="list-style-type: none"> • Use old power belts or fan belts from industrial machinery or tractors. Cut to fit and wire ends together. 	<ul style="list-style-type: none"> • no cost • long-lasting • wedged to fit wedge rim 	<ul style="list-style-type: none"> • bumpy ride • difficult to fit • may be hard to find at the right width
<p>Piece of old bicycle or scooter tire</p> 	<ul style="list-style-type: none"> • used for middle-sized or small wood wheels • Notch edges, glue, and nail to wheel. 	<ul style="list-style-type: none"> • cheap • If heavy tire is used it may last a long time. • Protects edge of wood wheel. 	<ul style="list-style-type: none"> • hard, bumpy ride (but softer than on wood wheel alone) • may tear off
<p>BIG WHEELS Standard factory-made wheelchair wheels</p> 	<ul style="list-style-type: none"> • Buy to fit chair. • available from wheelchair dealers • 24 inch (61 cm.) or 26 inch (66 cm.) rims for adults • 20 inch (51 cm.) rims for small children (may be hard to find) 	<ul style="list-style-type: none"> • little work needed (if they are bought to fit standard hubs) • May come fitted with hand push rim. 	<ul style="list-style-type: none"> • costly • may be hard to find • wide-wheeled models often not available • may not hold up on rough ground • poor quality bearings
<p>Bicycle wheels (rims and spokes)</p> 	<ul style="list-style-type: none"> • For children, standard thickness spokes may be enough. • For large persons, heavy-duty spokes may be needed. 	<ul style="list-style-type: none"> • less costly than standard wheelchair wheels • available in different sizes and widths 	<ul style="list-style-type: none"> • Putting on and lining up spokes takes time and skill. • axles weak (but stronger ones can be adapted)
<p>Bicycle rims with wooden spokes</p> 	<ul style="list-style-type: none"> • notched wood cross-pieces on a triangular wood base can be greased and used as the hub 	<ul style="list-style-type: none"> • no need to know how to fit spokes • works with wood hub 	<ul style="list-style-type: none"> • Rim may easily get bent—especially on rough roads. • hard to line up evenly • Hub wears out easily.

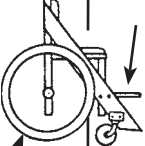
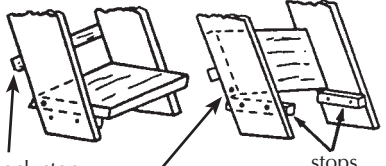
FEATURE	DESIGN DETAILS	ADVANTAGES	DISADVANTAGES
<p>Wood wheels—big or small</p> 	<ul style="list-style-type: none"> • Use boards or plywood. • To avoid splitting, screw and glue 2 layers together with grain running in opposite directions. • Cut notch in rim to hold solid tire. 	<ul style="list-style-type: none"> • relatively cheap • little skill required—mostly carpentry • works with wood axles • heavy-duty bearing can be added 	<ul style="list-style-type: none"> • often heavy • may not hold up long—especially in wet climate or mud (Keeping wood oil-soaked helps them last. Use old engine oil.)
<p>CASTERS AND WHEELS</p> <p>(Caster means that the wheel can swing in different directions for making turns.)</p> <p>Standard wheelchair caster wheels</p> 	<ul style="list-style-type: none"> • Casters come with hard or balloon tires in many sizes, weights, styles, and prices. <p>If possible, get (or make) casters with ball bearings.</p>	<ul style="list-style-type: none"> • little work to attach—especially if standard mount and bearings are used 	<ul style="list-style-type: none"> • usually very costly • may not be locally available
<p>Casters from other (non-wheelchair) equipment (used or new)</p> <p>for mounting into metal tube frame</p>  <p>for mounting on wood frame</p> <p>caster welded to metal plate for screwing to wood</p> 	<ul style="list-style-type: none"> • Use 3 inch to 6 inch wheels. • larger, wider wheels for rough ground • Be sure bearings are strong enough and in good condition. • Drill holes in rubber wheels to make them weigh less. 	<ul style="list-style-type: none"> • less costly (especially if not new) • often full wheel and caster bearings come with them 	<ul style="list-style-type: none"> • Poor quality casters make wheelchair much harder and more awkward to use. • Hard-rubber casters make a bumpy ride. • Some used casters are too weak.
<p>Bent and welded steel caster forks</p>  <p>30° angle</p> <p>bolt</p> <p>strong bronze weld</p> <p>holes to make fork weigh less</p> <p>hole sized to fit axle</p>	<ul style="list-style-type: none"> • Choose bolt width to fit bearings. • A bent steel tube can be used instead of a metal band. 	<ul style="list-style-type: none"> • less costly than factory-made casters • strong (if well made) 	<ul style="list-style-type: none"> • needs special equipment (bending jig) and welding skills
<p>HUBS, BEARINGS, AND AXLES</p> <p>Standard wheelchair bearings</p>  <p>ball bearings</p> <p>ball bearings at each end of hub</p> <p>axle</p> <p>hub</p>	<ul style="list-style-type: none"> • A standard wheelchair uses 12 bearings: 2 for each wheel axle and 2 for each upright caster bearing. • How a ball bearing works: <p>axle does not move</p>  <p>turning wheel</p>	<ul style="list-style-type: none"> • These bearings come as part of standard wheelchair hubs and wheels. • Most factory-built wheelchairs have unusual sized axles and therefore must be fit with special wheelchair bearings. 	<ul style="list-style-type: none"> • Bearings on most factory-built chairs are costly, of poor quality, and wear out quickly. • Unusual hub size makes it hard to replace commercial wheelchair bearings with other standard machine bearings.
<p>Bicycle bearings and axles</p>  <p>front wheel axle</p> <p>hub</p> <p>axle</p>	<p>For mounting alternatives, see wheelchair designs p. 598 and 615. Also, see the Healthlink Worldwide Manual (see p. 604).</p>	<ul style="list-style-type: none"> • cheap—especially if old bicycles are used • easy to get • can be used with complete bicycle wheels 	<ul style="list-style-type: none"> • Axle is too weak to be supported by one end only (except in a small child's wheelchair).

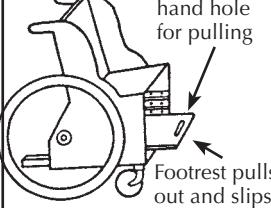
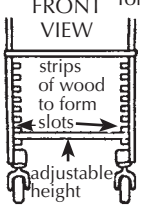
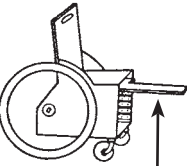
FEATURE	DESIGN DETAILS	ADVANTAGES	DISADVANTAGES
<p>Rear bicycle wheel axle and bearings</p> 	<ul style="list-style-type: none"> • First take free-wheel mechanism apart and remove ratchets. • Then attach hub to a metal plate as shown and spot weld it. • Other methods for one-end axle support are in the Healthlink Manual (see p. 604). 	<ul style="list-style-type: none"> • Allows axles to be attached by one end only. 	<ul style="list-style-type: none"> • Needs fairly skilled work and welding. • heavy
<p>Used machinery bearings</p> 	<ul style="list-style-type: none"> • Find used high-speed bearings of the size shown (or near the size). Volkswagen alternator bearings and certain power tool bearings work well. • Use 5/8 inch steel bolts for axle. For details, see p. 604, 622, and 623. 	<ul style="list-style-type: none"> • no need to adjust, grease, or clean • usually free or very cheap • In wheelchairs they will last a very long time. • If done well, results are better than with commercial hubs and bearings. 	<ul style="list-style-type: none"> • very careful, exact work needed for good results
<p>Wood bearing</p> 	<ul style="list-style-type: none"> • Use a hard wood that will not split. • Soak wood in old motor oil. • For more ideas and details on wood bearings, see Healthlink Worldwide Manual p. 604. 	<ul style="list-style-type: none"> • cheap and fairly easy to make 	<ul style="list-style-type: none"> • tends to wear out, wobble, or crack quickly unless very well made; not as smooth or easy to ride as with ball bearings
<p>SUPPORT OF AXLES</p> <p>Axle supported on one side only</p>  <p>This is the standard mount for factory-built chairs.</p>	<ul style="list-style-type: none"> • Strong steel axles are needed for support at one side only. Axle should be at least 5/8 inch thick for a large person. • For a very small child bicycle axles can be supported by one side only. One way is to weld bicycle axles to a thin metal pipe. 	<ul style="list-style-type: none"> • Not as wide or heavy as the chair with 2-side support. • easier for user to get a full-length push with hands and arms • narrow size important for doorways and transporting <p>Pass pipe through a wood frame, or weld to metal frame.</p> 	<ul style="list-style-type: none"> • For adults and large children, standard bicycle axles are too weak for one-side support. • Even for smaller children, bicycle axles are weak, and rough use can bend them. Put a sign on chair: <div style="border: 1px solid black; padding: 5px; text-align: center;"> <p>FOR SMALL CHILDREN ONLY</p> </div>
<p>Axle supported on both sides</p> <p>This can be done in several ways:</p> 	<ul style="list-style-type: none"> • Place outer bar of axle support so that it allows as much room for hand pushing by the rider as possible. 	<ul style="list-style-type: none"> • 2-sided support allows use of standard bicycle wheels and axles. • easy to build and replace 	<ul style="list-style-type: none"> • chair wider, more difficult to get through narrow doors and spaces; more difficult to transport • Wheel supports get in the way of hands when user moves by pushing wheels. • heavy 

FEATURE	DESIGN DETAILS	ADVANTAGES	DISADVANTAGES
<p>TO FOLD OR NOT TO FOLD</p> <p>A typical folding chair</p> 	<ul style="list-style-type: none"> • folding mechanism usually with 2 scissoring flexible cross pieces and cloth or leather seat • For details of a make-it-yourself model, see p. 622. 	<p>Folding:</p> <ul style="list-style-type: none"> • narrow when folded for easier transport or storage • smoother ride due to flexibility <p>Non-folding:</p> <ul style="list-style-type: none"> • cheaper and lighter • easier to make • more adaptable • often stronger 	<p>Folding:</p> <ul style="list-style-type: none"> • heavier • harder to make • more costly • less adaptable <p>Non-folding:</p> <ul style="list-style-type: none"> • Transport in cars and buses more difficult. Consider how much this will affect the child's ability to go where she wants. • stiff ride
<p>ARMRESTS</p> <p>No armrests</p> 	<p>Note: Many chairs are built so that armrests are part of the main structure and strength of the chair. The armrests cannot be easily removed, even though this might benefit the child. Carefully consider the child's need for armrests before buying or making a chair.</p>	<ul style="list-style-type: none"> • Many children with strong arms and trunk control prefer a chair with no armrests and a very low back support. • Moving by pushing the wheels is easier. • less weight • Getting off and on from the side is easier—especially important when legs are completely <i>paralyzed</i> and when arms are also weak. 	<ul style="list-style-type: none"> • Many small children need armrests for stability, for positioning, or for comfort.
<p>Fixed armrests</p>  <p>The so-called 'desk arm' lets front of chair fit under a table—but is often too high or too short.</p>	<ul style="list-style-type: none"> • Armrest height and length should be determined for each child and her needs. • For measurements, see p. 602. 	<ul style="list-style-type: none"> • especially helpful if child cannot use legs to get out of chair • They can help child to sit in a better position and be more comfortable. • They can sometimes be used for attaching a removable table. 	<ul style="list-style-type: none"> • They get in the way for pushing wheels and for getting off chair to the side. • For many children, fixed armrests get in the way more than they help.
<p>Removable armrests</p>  <p>adjustable armrest</p> <p>Armrest fits into these tubes.</p>	<ul style="list-style-type: none"> • In folding chairs, armrest attachments must be placed so they do not get in the way of folding.  <p>child transferring from a chair on a board—one armrest removed</p>	<ul style="list-style-type: none"> • Provides arm support when needed, yet can easily be removed for travel and transfer. 	<ul style="list-style-type: none"> • requires more work, materials, and exact fittings • adds slightly to weight • Separate armrests may get lost.

FEATURE	DESIGN DETAILS	ADVANTAGES	DISADVANTAGES
<p>FOOTRESTS</p> <p>Positions</p> <p>In adult chairs, footrests often angle legs forward to leave room for casters.</p>  <p>For a small child, often footrests can position legs straight down. This is important in many cases (see p. 591).</p>  <p>A larger child may need to sit on cushions so that his feet are above the casters.</p>	<ul style="list-style-type: none"> • Footrest should keep the knees and ankles at right angles and the legs slightly separated • It should usually not twist them or force them together.  	<ul style="list-style-type: none"> • Good positioning and support of the feet help the whole body to stay in a better position. <p>A footrest like this, may help feet like these.</p> 	<ul style="list-style-type: none"> • A footrest that keeps the leg at right angles may cause or increase knee contractures in some children. Children should not stay sitting too long and should do daily exercises to stretch their legs, feet, and hips. <p>To prevent or correct contractures, one or both legs may need to be kept as straight as they will go.</p> 
<p>Fixed position footrests</p> <p>The height of the rests should be carefully measured to fit the child who will use them. (For measurements, see p. 602.)</p>  <p>REMEMBER: Cushions or seating adaptations will change the height needed for the footrests.</p> 	<ul style="list-style-type: none"> • If the footrest is too low, blocks can be placed on it to make it higher. They can be removed as the child grows. • However, fixed footrests that are too high are more difficult to correct. So it is better if they are too low. 	<ul style="list-style-type: none"> • easiest to build • For a small child who can easily be lifted in and out of the chair, they are fine. • If footrests are screwed or bolted onto a wooden wheelchair, their position can easily be changed as the child grows. 	<ul style="list-style-type: none"> • They often get in the way when the child gets in or out of the chair, or in the way of the person lifting a larger child. (See other methods below.)
<p>Removable or swing-away footrests</p> <p>wood chair swing-away footrest</p>  <p>back-stop for feet</p> <p>pin on which footrest swings</p> <p>stops</p>	<p>There are many designs. Here we show one for the wood chair shown above and one designed for a metal chair.</p> <p>Other designs for sliding or swing-away footrests are on pages 616, and 622.</p> <p>metal chair footrest</p> <p>swing up</p>  <p>See p. 622.</p>	<ul style="list-style-type: none"> • They make it easier to get in and out of chair. • The best footrests are those the child can easily move out of the way herself. 	<ul style="list-style-type: none"> • Removable footrests may get lost. • more work to make them • Unless well-made, they may be less stable than fixed footrests.
<p>Adjustable footrests</p>  <p>hand hole for pulling</p> <p>Footrest pulls out and slips back out of way.</p> <p>Also serves as storage shelf.</p> <p>FRONT VIEW</p>  <p>strips of wood to form slots</p> <p>adjustable height</p>  <p>For straight leg sitting, a longer board fits into high slots.</p>  <p>leg board for both legs</p>  <p>leg board for one leg</p>	<p>There are many designs. Here is one of the simplest, for a plywood chair.</p>	<ul style="list-style-type: none"> • very adaptable • easy to make • can support a casted leg 	<ul style="list-style-type: none"> • A cushion or padding should be placed over the leg board (unless leg is casted). • Side supports may be needed to keep leg from slipping off. 
<p>No footrests</p> 	<ul style="list-style-type: none"> • Seat is mounted low so that feet rest flat on floor. 	<ul style="list-style-type: none"> • useful for persons who can pull their chair along with their legs and feet—especially when one or both arms or hands are too weak to push the wheels 	<ul style="list-style-type: none"> • Feet may drag when someone else pushes the child in the chair. Swing-away footrests may be the best solution.

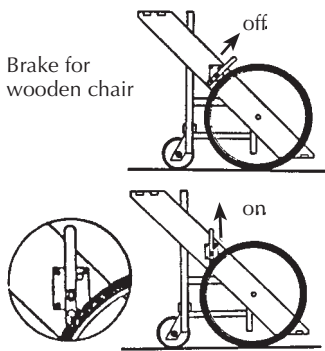
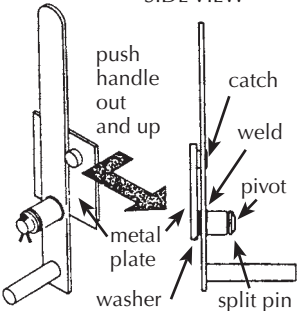
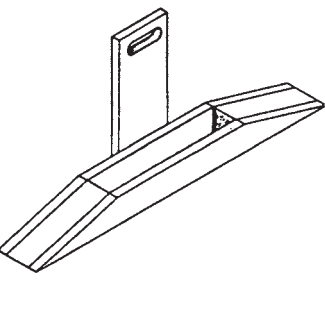
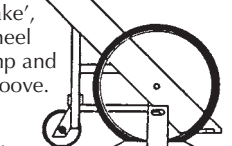
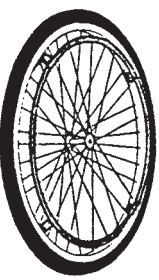
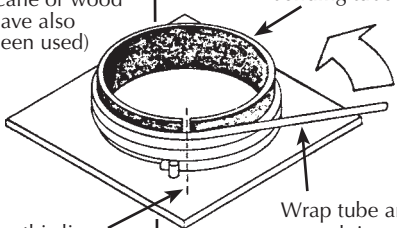
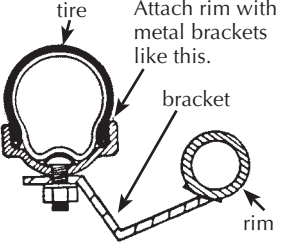
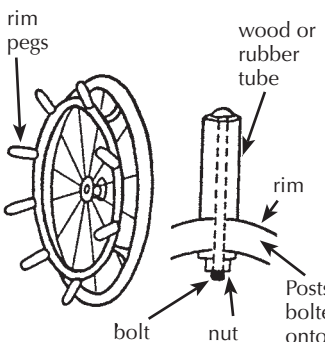
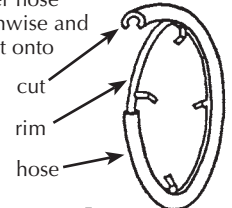
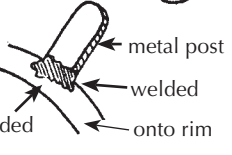
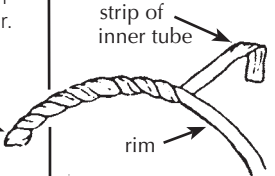
FEATURE	DESIGN DETAILS	ADVANTAGES	DISADVANTAGES
<p>PARKING BRAKES Lever brakes</p> <p>Brake for wooden chair</p> 	<p>There are many brake designs. This one is from Healthlink Worldwide. Two others are on p. 623.</p> <p>SIDE VIEW</p> 	<ul style="list-style-type: none"> • takes little space • fairly easy to use if made right (which often they are not) 	<ul style="list-style-type: none"> • needs welding and skill to make • Homemade brakes often give problems—yet it is important that chairs have them if possible.
<p>Parking block</p> 	<p>Brakes on wheelchairs are for keeping the chair from rolling when getting in or out, or stopped on a hill.</p> <p>The simplest form of brake is a parking block that keeps the wheel from turning.</p> <p>To 'brake', roll wheel up ramp and into groove.</p> 	<ul style="list-style-type: none"> • easy to make, requires no welding, and is cheap • If the child usually only gets in and out of the chair in one or two places in the home, blocks in these places may be all that is needed. 	<ul style="list-style-type: none"> • a heavy, awkward object to move from place to place • not practical outside the house (or in it) • have to tilt child to one side to 'park' chair
<p>HANDRIMS FOR PUSHING</p> <p>using thin metal tubing (cane or wood have also been used)</p>  <p>Cut down this line before removing from jig. Weld ends.</p>	<p>Designs taken from Healthlink Worldwide. See p. 604.</p> <p>jig for bending tube</p>  <p>Wrap tube around several times to make several rims at once.</p>	<ul style="list-style-type: none"> • Handrims help keep hands clean. (Otherwise child has to push on tire.) • especially important where there are very dirty paths and roads <p>Attach rim with metal brackets like this.</p> 	<ul style="list-style-type: none"> • Added width makes it harder to get through narrow doorways. • adds weight
<p>Handrim grip improvers</p> 	<p>Cut a piece of rubber hose lengthwise and tape it onto rim.</p>  <p>Posts can be bolted or welded onto rim.</p> 	<ul style="list-style-type: none"> • For child with weak or paralyzed hands, a smooth rim can be hard to grip—especially if it is chromed or galvanized. • Putting rough cloth tape, a rubber hose, or many small handles on the rim will make pushing easier. • Or you can wrap the rim with a long thin strip of car tire inner tube. 	<ul style="list-style-type: none"> • Pegs sticking out from rims increase width of chair. • Pegs sometimes cause hand injuries— especially when going fast downhill. 

Fitting the chair to the child: measurements

These measurements are for **wheelchairs** and for **special seating without wheels**.

SEAT WIDTH

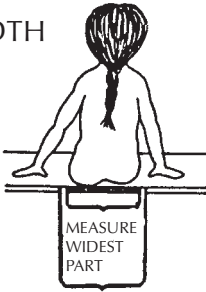

Measure across hips or thighs—whichever is wider.

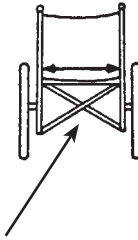

Note: Some specialists recommend wider seats. But the child gets a better arm position for pushing the wheels if only 1 cm. is added on either side. However, you may want to leave a little more room to allow for the child's growth.

Add 1 cm. (1/2 inch) to both sides for seat width.

SEAT DEPTH

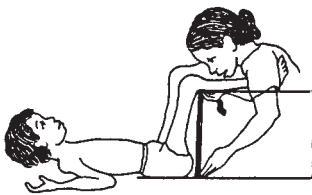

MEASURE FROM BEHIND KNEE TO BACK OF BUTT

Subtract about 1 cm. for depth of seat to leave a little space behind the knees.

Note: You may want to add 2 cm. or 3 cm. to allow for growth and use a backboard or firm cushion to fill in the extra space.

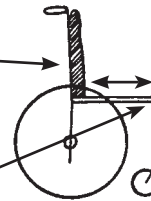

CAUTION: When measuring, be sure to allow for cushions or backboards that will be added.

SEAT HEIGHT

CAUTION: Be sure to include cushion when measuring height for chair seat.

Note: Raising the seat of a small child higher lets his feet rest above the casters and therefore directly below the knees. The higher seat also helps for eating at the table with the family. Sideways transfers are also easier. Sometimes seats are placed even higher than shown, but this makes pushing wheels with hands more difficult.

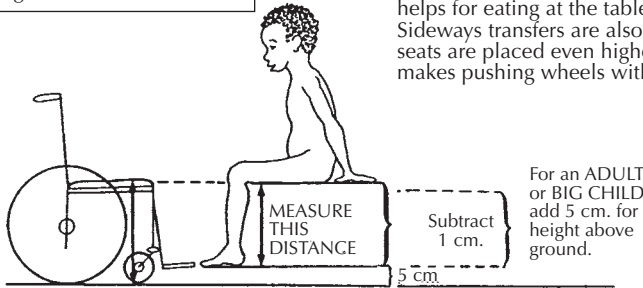

For an ADULT or BIG CHILD, add 5 cm. for height above ground.

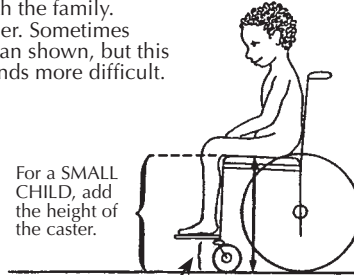

For a SMALL CHILD, add the height of the caster.

height of caster

ARMREST HEIGHT

MEASURE FROM BOTTOM OF BUTT TO BEND OF ELBOW.

Before measuring, be sure child is sitting as straight as possible.

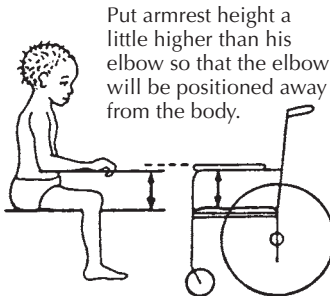

Put armrest height a little higher than his elbow so that the elbow will be positioned away from the body.

Note: This measurement is standard, but some children need arm support at a higher level. Experiment.

BACK HEIGHT

MEASURE FROM BOTTOM OF BUTT TO ARMPIT

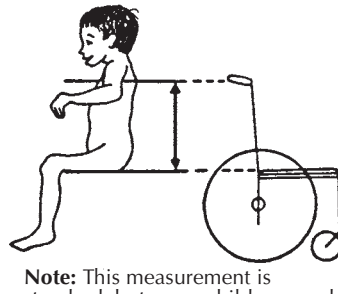

Note: This measurement is standard, but some children need a higher back, and sometimes head support. Others prefer a back that supports only the hips.

IMPORTANT: Also check how much hips and knees bend, as this may affect position of footrests and casters.

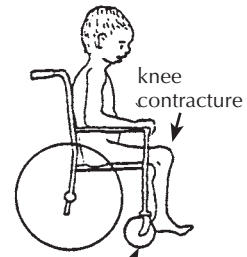

Caster here will not work.

Wheelchair production as a small 'village-industry'

In several countries small groups of disabled persons have started to produce low-cost, good-quality wheelchairs adapted to local needs. Usually this is in places where standard factory-made wheelchairs are very high-priced and are not suited for use on rough or sandy ground.

Some of these 'little factories' try to be self-sufficient. A few have even succeeded in making a modest profit, while keeping prices low.



A disabled worker from PROJIMO paints a wheelchair frame.

Sometimes, a small-scale wheelchair making and repair shop is set up as part of a community rehabilitation program. Self-sufficiency (selling the chairs for a little more than it costs to make them) is often a goal. But because families with the greatest need are often least able to pay, the chairs must often be sold below cost.

WHAT KIND OF WHEELCHAIRS TO MAKE

This depends on many factors: cost, skills or training available, tools and equipment needed, amount of money available to start, building materials available, the possible market, the local economy, and needs of the wheelchair user and family.

For example, folding tube-metal chairs are relatively expensive to make and require more skill, training, and equipment. However, they often work smoother, last longer, and are easier to transport than are many other models. These high-quality, good-looking chairs—painted or even chrome plated—may sell the best, even if expensive, and may compete with factory-made chairs (see p. 622).

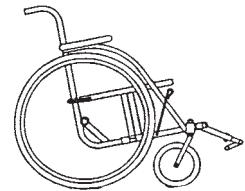

If the wheelchair users will be mostly children and poor families, low-cost wooden chairs may be more appropriate. These can be easily built to size and adapted to the needs of the individual child. The chair may not last as long. But the child is growing and her needs may change. Simple wood chairs also require fewer skills to build—mainly carpentry. They are easier for the family to build, repair, or add changes to at home.

Ideally, a village shop would make a variety of chairs out of different materials and at different prices. Chairs of all models, sizes, and adaptations should be kept on hand to give the child and family a chance to know and try different possibilities. **Be sure to make child-sized chairs. And make chair inserts so that adult-sized chairs can be adapted for children.**

Look for every opportunity to keep costs low. Providing **repair services** for used and broken chairs are good ways to keep children on wheels. Also use as much 'waste', and used and free materials as you can: old bicycle wheels, old machinery bearings, scrap metal, and bolts from junk yards. For basic building materials, check prices of different sellers. Once you are sure of what you need, try to buy large amounts at lower cost. If you explain to the sellers the purpose of your purchase, they may lower prices or give you useful scraps.

Designs for 6 different wheelchairs are in Chapter 66.

How-to-do-it reference materials for wheelchairs, wheelboards, and other seating

It is impossible, in a book such as this, to give detailed building plans for more than a few wheelchairs, scooters, wheelboards (trolleys), and special seats. The following reference materials have more detailed plans. You can send for them at the addresses shown. Some may also be available from TALC, P.O. Box 49, St. Albans, Herts, AL1 4AX, England. With each reference we give one or more drawings of key designs and a few comments about their usefulness and cost.

Personal Transport for Disabled People—Design and Manufacture

Healthlink Worldwide
56-64 Leonard Street,
London EC2A 4LT,
UNITED KINGDOM

Also available through TALC

- many good designs and plans for low-cost aids
- does not compare strengths and weaknesses or describe limitations of different designs
- no design for wheelchairs with casters in front (which are needed for many areas)

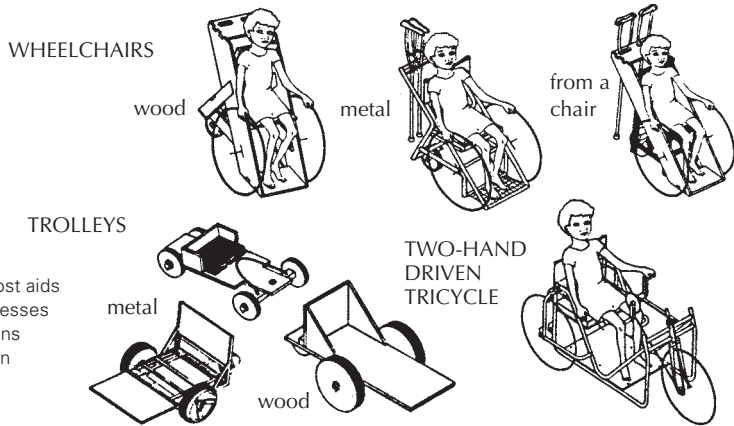

Independence through Mobility: A Guide to the Manufacture of the ATI-Hotchkiss Wheelchair

Whirlwind Wheelchair International

San Francisco State University,
1600 Holloway Ave. SCI 251,
San Francisco, CA 94132, USA

- design for the 'whirlwind', a high-quality middle-cost steel tube wheelchair that can be built by disabled craftspersons as a village industry
- short training usually needed to build it effectively; welding skills and simple math required
- cost of materials about US \$100

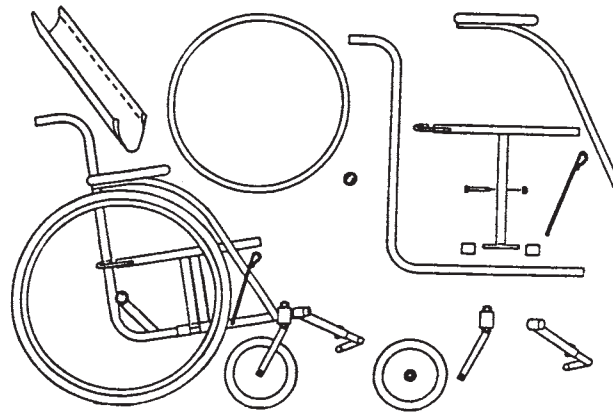

Local Village-made Wheelchairs and Trolleys

by Don Caston

Available upon request.

DON CASTON
202 Cheesman Terrace
London W14 9XD
ENGLAND

- simple, very low-cost aids, made mostly out of wood, using bicycle or wood wheels
- all models are based on one 3-wheel trolley design
- Instead of a standard caster, the front slides on its axle and is pushed back to center by a choice of simple methods. (This method is cheap and clever, but unstable and does not turn as well as designs with casters.)

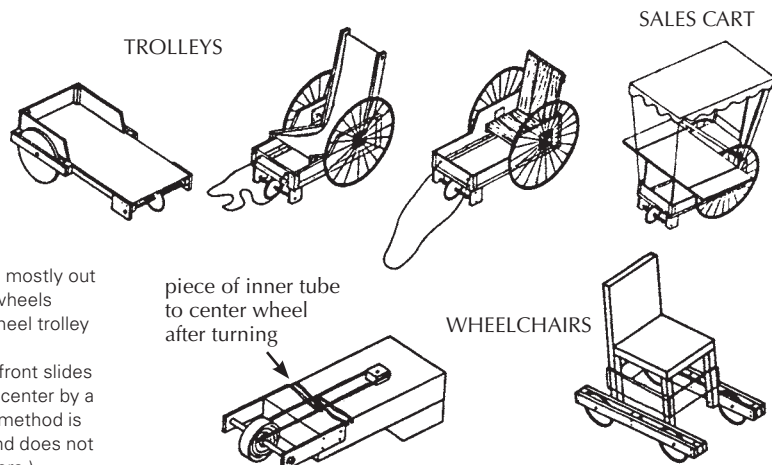

Asia-Pacific Disability Aids and Appliances Handbook, International Commission on Technology and Accessibility (ICTA)

Rehabilitation International
25 E. 21st Street, 4th floor
New York, NY 10010, USA

- brief descriptions and non-technical drawings and addresses for information on many aids

TROLLEYS

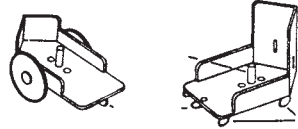

ADAPTED TRICYCLE

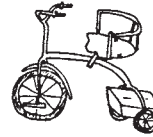

ONE-HAND POWERED TRICYCLE

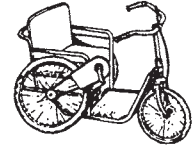

'HOMEMADE' ELECTRIC WHEELCHAIR USING CAR FAN MOTOR AND BICYCLE PARTS

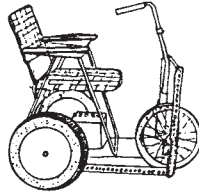

WHEELCHAIR TO BE PULLED OVER ROUGH GROUND



TILT CART

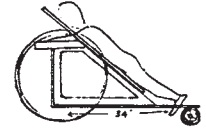

An Accent Guide to Wheelchairs and Accessories

ACCENT
P.O. Box 700
Bloomington, IL 61702
USA

- information about different aids, features, and accessories of factory-made chairs
- basic information on cleaning and repairing
- design and building information limited to a few accessories

LAP TRAYS



BACKS

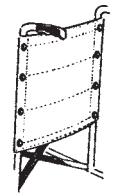

REMOVABLE ARMRESTS

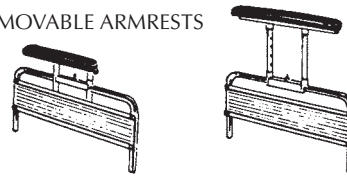

UPKARAN: A Manual of Aids for the Multiply Handicapped

Bandra Reclamation
K.C. Marg, Bandra (West)
Mumbai 400 050, INDIA

- an excellent resource
- many simple, practical designs for seating, wheelchairs, crawlers, standers, walkers, therapy aids, and toys

SEATS

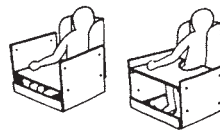

adjustable

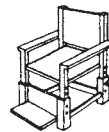

WHEELCHAIRS

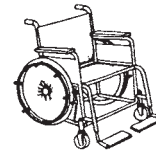

toilet adaptation

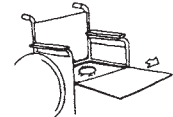

PUSH-ALONG

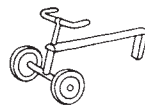

TRICYCLE WITH SUPPORT

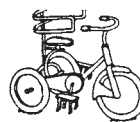

WALKER-RIDER

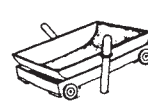

TIRE SCOOTER

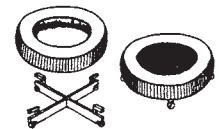

How to Make Basic Hospital Equipment
Practical Action Publishing

The Shumacher Centre
for Technology and Development
Bourton on Dunsmore
Rugby, Warwickshire
CV23 9QZ UNITED KINGDOM

Also available through TALC and Healthlink Worldwide

- simple, attractive designs using tube steel
- welding skill required; fairly costly to make
- no designs for casters-in-front chairs

HOSPITAL WHEELCHAIR



OUT-OF-HOSPITAL WHEELCHAIR (2 wheels only)



BICYCLE AMBULANCE

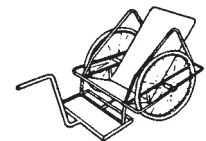

CHAIR MADE WITH WHEELS OF RATTAN (also works as a walker)

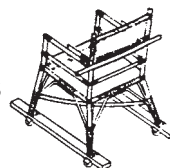

ONE-HAND DRIVEN TRICYCLE

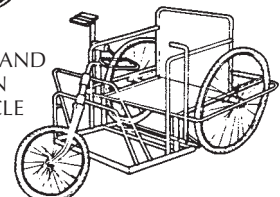

**Poliomyelitis—
A Guide for Developing Countries**
by R.L. Huckstep
Churchill Livingstone
5 S. Fontenac Road
Naperville, IL 60563 USA

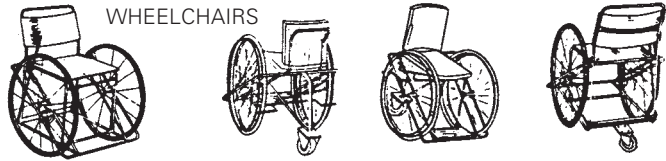

- detailed designs for 3 models of wheelchairs commonly used in Africa
- only casters-at-rear designs (which often may not be the most appropriate design)

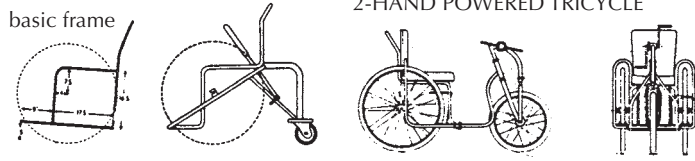

**Positioning the Client with Central Nervous System Deficits:
The Wheelchair and Other Adapted Equipment**
by Adrienne Falk Bergen
and Cheryl Colangelo
Valhalla Rehabilitation Publications, Ltd.
P.O. Box 195 Valhalla, NY 10595 USA

- excellent detailed discussion of specific needs of children with cerebral palsy
- many well-illustrated examples
- written for developed countries but many aids and designs are simple and can be made anywhere at low cost

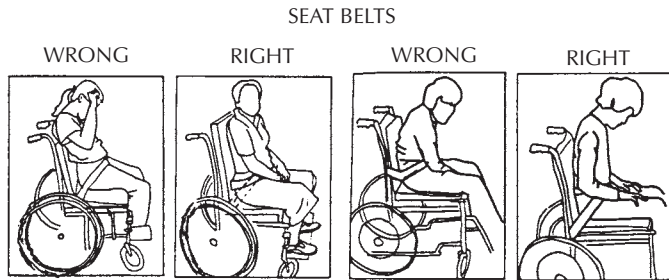

WRONG RIGHT
This child, whose hips tilt forward, needs a higher belt.

WRONG RIGHT
This child, whose hips tilt back, needs a low belt.

'Build Yourself' Plastic Wheelchair

Directions for assembly available from:
Spinal Research Unit
Royal North Shore
Hospital of Sydney
St. Leonards, NSW 2065 Australia

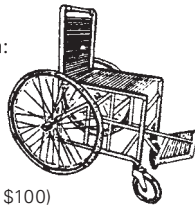

- relatively expensive (materials about US \$100)

- plastic frame made of 9 m. of 15 mm. PVC pressure pipe; plastic set of 8 mm. soft PVC tubing; 2 rear 24 inch bicycle wheels; 2 front casters (15 mm.)
- Plastic will sag with continued use.
- uses standard bicycle axles—which will bend with the weight of an adult or large child
- relatively lightweight
- does not fold
- design plan complicated and difficult to follow

Measuring the Patient

Everest and Jennings, Inc.
Graham-Field Health Products
3601 Rider Trail South
Earth City, MO 63045-1116
USA

- good information on measurements for standard chairs
- illustrated discussion of problems with chairs that do not meet a person's specific needs

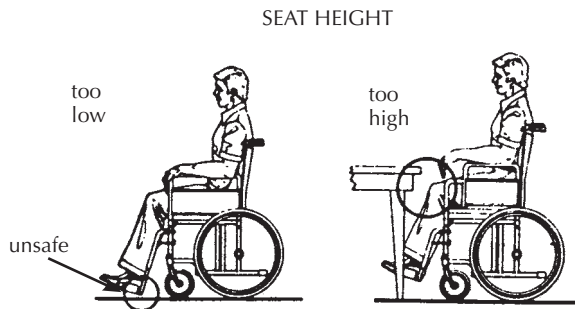

Functional Aids for the Multiply Handicapped

by Isabel Robinault
Harper and Collins Sales
10 East 53rd Street
NYC, NY 10022 USA

- mostly factory-built examples but some are simple and well-illustrated enough to serve as design guides
- many good wood special seats
- also support frames, standers, walkers, toys, and eating aids

SMALL-WHEELED ADJUSTABLE WALKERS

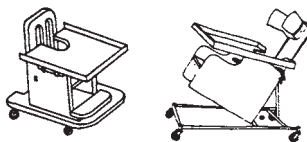

CHILD'S TRICYCLE WITH BODY SUPPORT BOLTED TO FRAME



SCOOTER THAT IS ALSO A WHEELED STANDER



SUPPORT FRAME

