

Adaptations for Wheelchairs and Other Sitting Aids

CHAPTER 65

CP

Many children need more support or special positioning than is usually provided by a regular chair or ordinary wheelchair. So we should try to get or make a chair designed to fit the individual child. Unfortunately many children get wheelchairs that are much too big. Often no others are available. Here are 3 ways to adapt them.

1. **If a folding chair is too wide**, make the cloth seat and back narrower. The chair will not open as wide (but may be too high).

TOO WIDE NARROWER (BUT HIGHER)

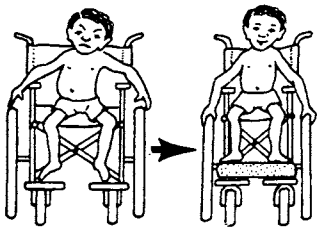

Be sure to check how well the child can reach to turn the wheels

2. **If the chair is too big from front to back**, or if the child needs a better position, try a wedged cushion and padded backboard.

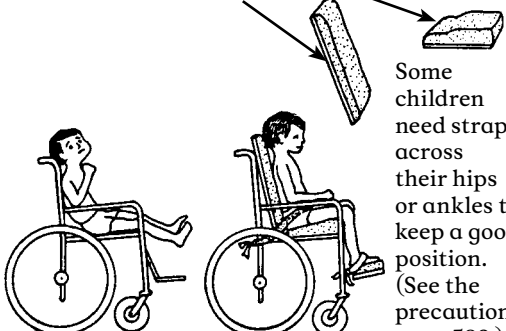

Some children need straps across their hips or ankles to keep a good position. (See the precaution on p. 589.)

3. **If still more help is needed** for positioning the child, make a **sitting frame** designed to meet her needs. Here is an example.

CAUTION: Some children will need fewer or different features than those shown here. Adapt features to the needs of the particular child, and test them before making them permanent.

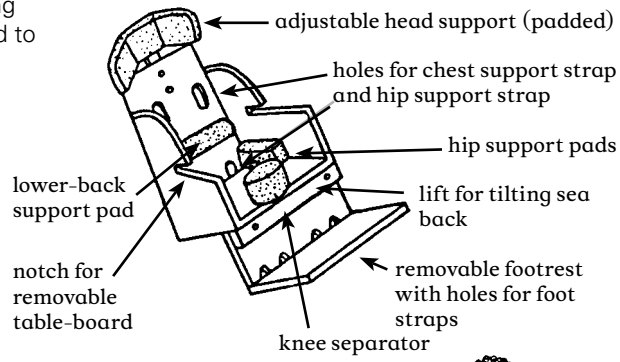

adjustable head support (padded)
 holes for chest support strap and hip support strap
 hip support pads
 lift for tilting seat back
 removable footrest with holes for foot straps
 knee separator
 lower-back support pad
 notch for removable table-board

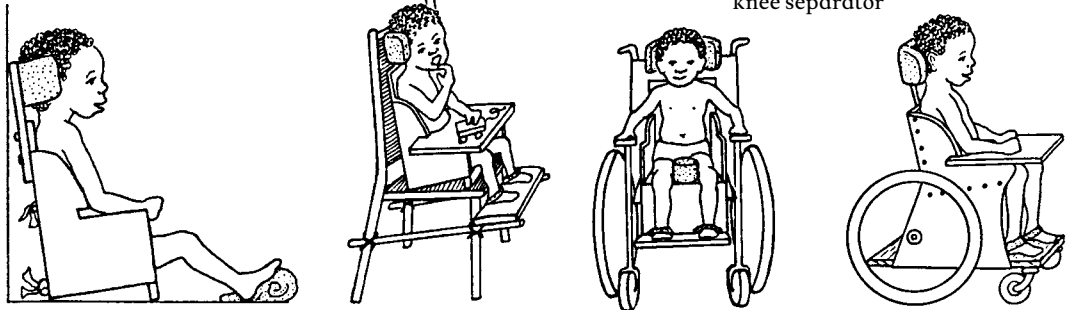

The sitting frame can be used on the ground.

It can be placed in a chair (or strapped into the seat of a car).

It can be fitted into a wheelchair.

Or make a simple wood wheelchair with all the features of the sitting frame (see pp. 620 and 621).

CP Seating adaptations for specific children

The various adaptations discussed here are designed to meet specific needs of individual children, especially children with cerebral palsy. Remember that each child's needs are different, and adaptations that are not carefully fitted to the needs of the child may do more harm than good.

1. Carefully consider the child's specific needs before including any adaptation or special seating.
2. After making an adaptation, evaluate how the child uses it.
3. Check often to see if it continues to help the child. An adaptation for a growing child may help her progress at one stage of development but hold her back a few weeks or months later.

General position

We have talked about this a lot, but it is worth repeating:

Most children who require special seating sit best with their hips, knees, and ankles at right angles.

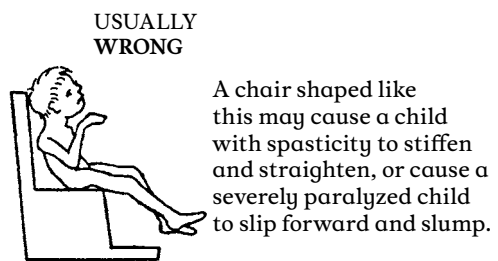
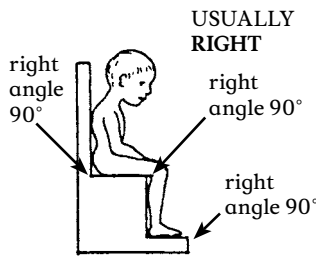

ANGLE OF BODY AND HEAD

A slight backward tilt helps most children sit in a better, more relaxed position.



If the child still falls or stiffens forward,



it may help to tip the chair back even more.



However, this may cause his head to lean back so his eyes look upward.

A head pad may help position him to look forward, and may decrease some spasticity. It can also reduce spasticity in the eye muscles.

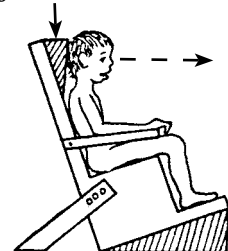

The heads of babies and small children may be so big that the headrest tilts them forward so their eyes look down.

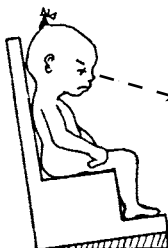

Putting the headrest behind the level of the backboard lets the child hold her head in a better position.

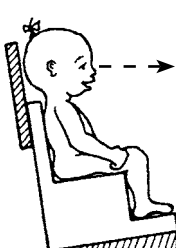



REMEMBER:
All the seating ideas shown on these pages apply to wheelchairs, and also to special seats without wheels.



Other ways to help keep hips at a right angle

HIP STRAPS

If the hips tilt back like this,

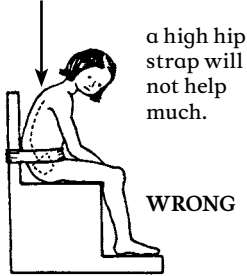

WRONG

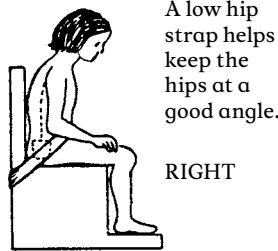

RIGHT

But if the hips tilt forward like this,

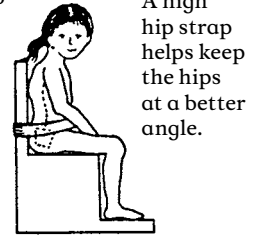
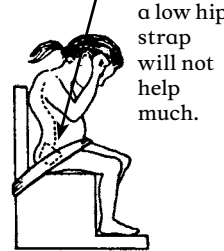

Notice that in both of these children with cerebral palsy, supporting the hips in a better position helps the whole body take a healthier position.

SPECIAL CUSHIONS

For the child whose hips tilt back, or whose upper body is floppy, a padded support across the lower part of the back may help her keep a good position.

Good cushions sometimes make straps unnecessary.

WITHOUT CUSHIONS

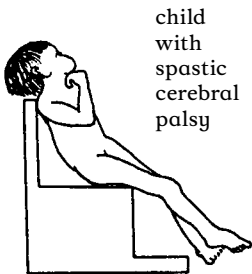

child with spastic cerebral palsy

WITH CUSHIONS

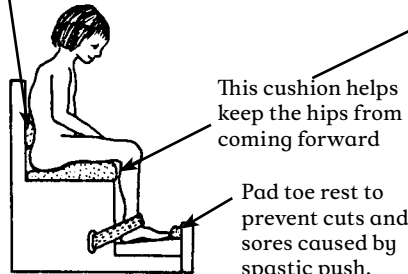

This cushion helps keep the hips from coming forward

Pad toe rest to prevent cuts and sores caused by spastic push.

sponge rubber padding

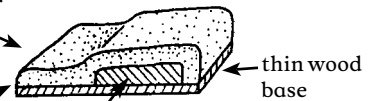

block to keep hips from slipping forward

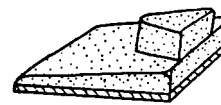

A padded post may also help to keep hips back and legs apart (see next page).

A footstrap or block that keeps knees bent may help keep the child from straightening stiffly.

Note: Cushion designs for spinal cord injury are on p. 200.

Keeping the body straight from side to side

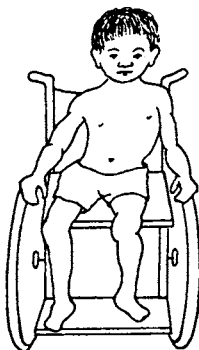

Even with a firm board seat, this boy's body sags to one side. This can lead to increasing curve of the spine (scoliosis).

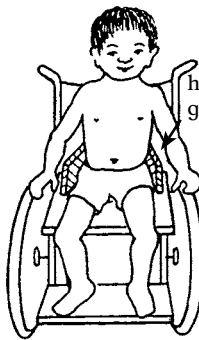

Hip guides may help him sit straighter.

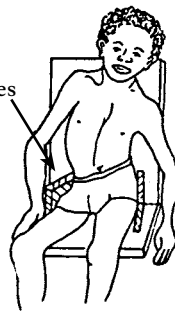

Sometimes, hip guides alone are not enough.

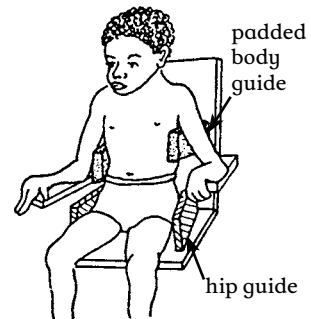

He may also need carefully placed body guides, to help keep his body in a straighter position.

CP Deciding where to place body guides

1. Look carefully at how the child sits.

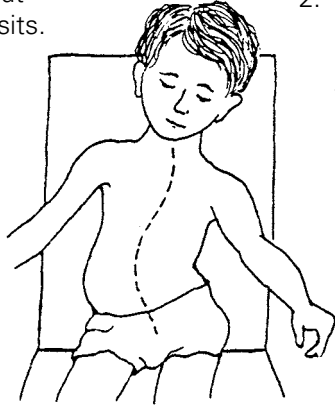

2. Draw a sketch of how he sits. Then draw arrows where you would need to push to help him sit straighter.

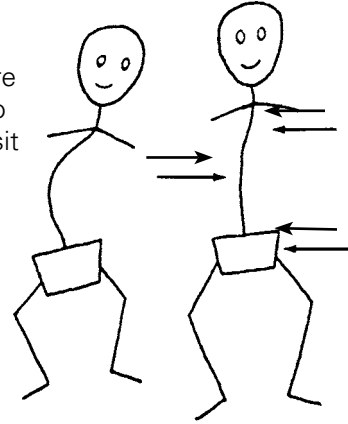

3. While someone holds the child in his best position, mark where you think the guides should be placed.



4. First, build in the guides in a temporary way.

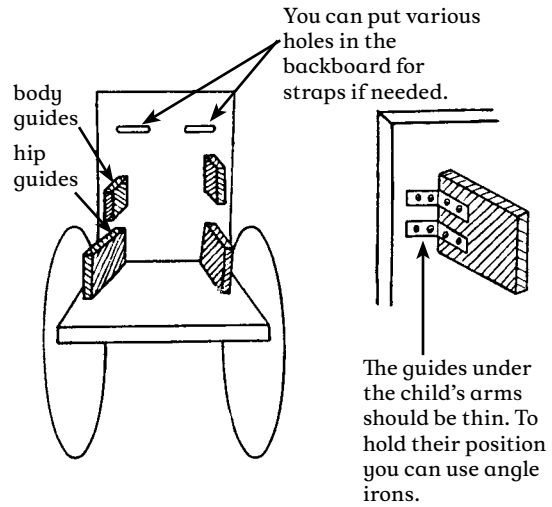

5. See how well the child sits in the adapted seat. When you cannot improve it more, fasten the guides firmly and pad them so they do not hurt him.

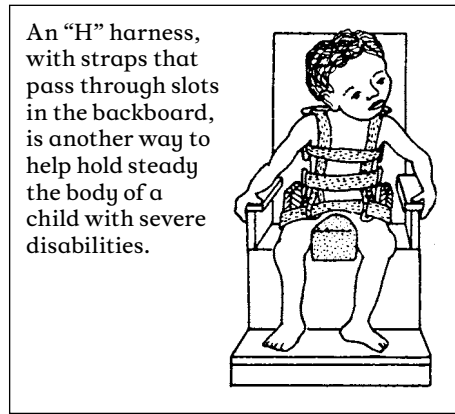
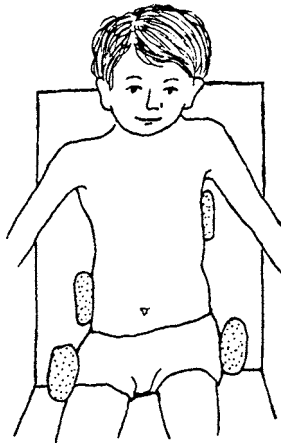



Carefully evaluate what kinds of support each child needs

Maria's legs straighten, press together, and turn inward. Her whole body position is affected.

A hip strap holds her hips back some but does not help her overall position much.

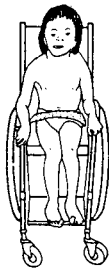

However, a backboard that bends her hips more, plus a knee post, help improve her whole body position —without straps!

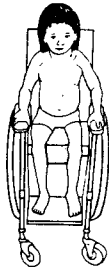

Pedro's body stiffens and his knees push open.

A combination of a backboard with guides, a special cushion and a knee block does not help him.

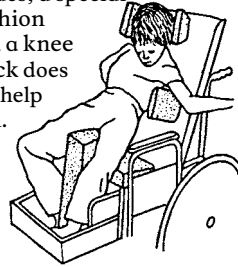

However, a hip strap together with blocks outside his knees gives him a much better position. (He may also need foot straps.)

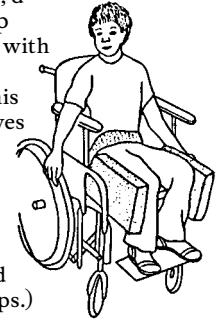

SHOULDER-BLADE WINGS

Pablito has spastic cerebral palsy, and his muscles pull his shoulders back and make it hard for him to bring his hands together in front of him. The village team had an idea.

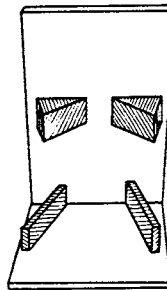
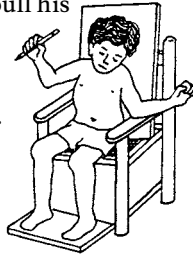

They put "wings" behind his shoulder blades, like this, to help keep his shoulders forward.

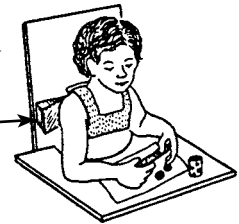

Now Pablito can bring his hands together and play more easily.

LAP BOARDS

These can be made from thin wood, plywood, or fiberboard. They should be easy to take off, but grip firmly when in place.

You can make a simple instrument out of cardboard or stiff paper to measure the child's body for cutting out the lap board.

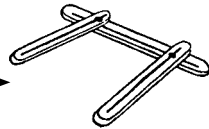

Extra holes for changing peg position.
Raised edges help keep toys from falling.
Two pegs to hold onto may help him sit, or move into a better position. They also help him develop hand control (games with rings, etc.).

A lap board can help keep shoulders, arms, and body in a better position, especially if it has a part cut out measured to fit around the child.

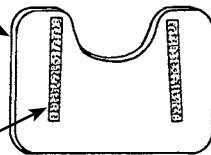

Velcro (stick-to-itself tape) can be used to fix the board to the chair for easy removal —and to adjust it forward or backward.

Be sure to put the softer part of the Velcro on the chair arms. The rough parts could scratch the child when the board is not used.

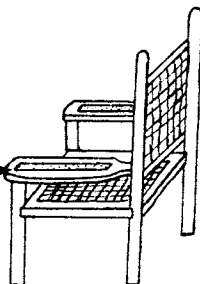

Height of the lapboard is usually the same as for armrests (see p. 602). Experiment to find out what works best.

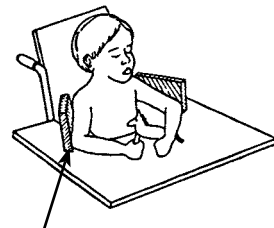
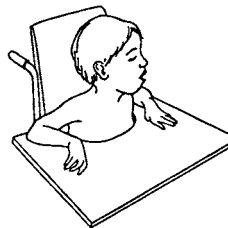

If needed, arm guides can be used with a lap board to keep a child's shoulders forward and his arms in a better position to use his hands.



DESIGN FOR A WHEELCHAIR INSERT

This insert, from *Positioning the Client with Central Nervous System Deficits*, provides a lot of control, and is especially useful for some children with spasticity. Although it was designed as an insert for a wheelchair, you can use it as the frame of a wooden wheelchair, or chair without wheels built for a specific child.

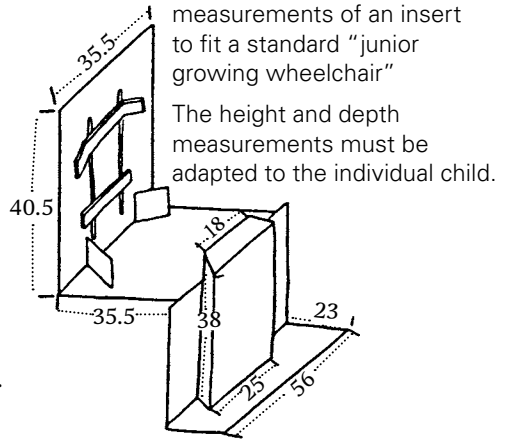
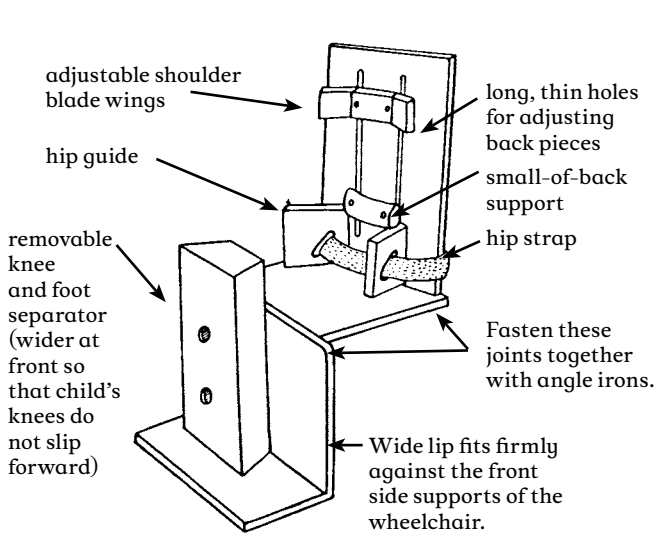

measurements of an insert to fit a standard "junior growing wheelchair"
The height and depth measurements must be adapted to the individual child.

Measurements are given in centimeters (cm). To change to inches, divide by 2.5.

DESIGN FOR A STRAIGHT-LEG SITTING FRAME

(mostly for very young children)

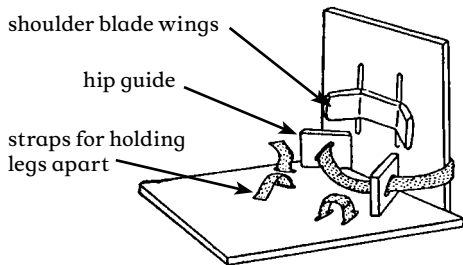

To seat the child, the frame can be put on the ground, a table, a chair, or into a wheelchair.



DESIGN FOR AN ADAPTED CASTER CART (WHEEL BOARD)

Use the same suggestions for supports, guides, and straps.

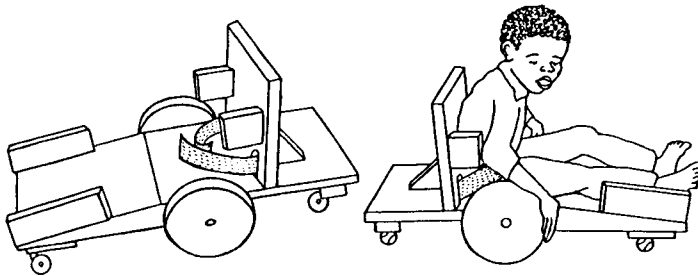

Note: The child's weight is over the large wheels. He can rock from one caster to the other. For travel over rough ground, he will learn to balance on the center wheel and barely touch down with the others.

CAUTION: Be sure to add cushions or adequate padding to all seating designs. Children whose bodies push in uncontrolled ways can very easily develop pressure sores (see Chapter 24).