

CHAPTER 23

Manual vacuum aspiration (MVA)

In this chapter:

Deciding when to do MVA 422

Getting ready for the MVA..... 423

 Help the woman to be comfortable. . 423 Prepare tools and supplies for
 Preventing pain during MVA 423 doing MVA 424

Doing the MVA..... 426

 Injections to numb the cervix. 428

Problems with the MVA..... 432

 The cannula comes out of
 the womb 432 The cannula becomes clogged 433

 The syringe is full 433 Problems that MVA can cause 434

After the MVA..... 434

Manual vacuum aspiration (MVA)



Manual vacuum aspiration (MVA) is a fast and safe way to empty the womb using a large syringe and cannula. It can be used:

- to help a woman who has had a miscarriage or abortion that was not complete.
- to regulate monthly bleeding.
- to end an unwanted pregnancy.

Using MVA to empty the womb is done the same way in each case.

In this book we explain how to use MVA to help women who have had incomplete abortions or miscarriages — when a pregnancy ends early but some tissue is left in the womb. Also see Chapter 22 which explains other ways to help a woman after an abortion or miscarriage. MVA is only part of the care that she needs.



While not as safe or simple as using misoprostol with (or without) mifepristone (see page 488), MVA is safer, simpler, and less expensive than surgical methods used to empty the womb. MVA can be done by midwives, nurses, or anyone who has been trained, who has the right tools, and who can sterilize those tools. If midwives and others learn to use MVA safely, more women, especially poor women and women who live in villages far from medical care, will have access to safe abortions and to life-saving care after incomplete miscarriage and abortion.

Some notes about learning MVA

- Before you use this chapter you must understand **infection prevention** (Chapter 5) and **pelvic exams** (Chapter 20).
- Find out what the law is where you live. Only in some places are midwives encouraged to learn MVA. In other places, midwives are not allowed to practice it.
- Doing MVA improperly can cause an infection in the womb or injury to the womb. Use this chapter to help you learn, but remember, you cannot learn as much from a book as you can from an experienced teacher. **You must be trained to do MVA by someone with experience.**

Deciding when to do MVA

Women who have tissue left in the womb after an incomplete miscarriage or abortion can die from infection or bleeding. MVA can help save their lives.



But MVA is also dangerous unless it is done carefully. To do MVA, you must put something into a woman's womb. Putting anything inside a woman's womb is risky because if it is not done correctly, it can give her a serious infection, or injure her womb.

Also, MVA can be done safely only up to 16 weeks of pregnancy.

Before you do an MVA, you should be sure that there is not a safer alternative. Is there a medical center nearby where health workers can empty the womb?

Would this be an appropriate time to use misoprostol (see page 488) instead of MVA? **Only use MVA if it is the safest way to empty the womb.**

For an MVA to be safe you must:

Have sterilized equipment

Everything that goes inside a woman's womb must be sterilized (see page 59). If you cannot sterilize your tools before doing an MVA, you cannot make it safe and you should not do it!



Be trained and experienced

You cannot learn enough from any book, including this book, to do an MVA safely. You must be trained by an experienced person. Learn as much as you can from books, classes, and teachers. Help someone more experienced when she is doing an MVA so you can watch and learn.

Know that MVA is the appropriate care for the woman

Talk with the woman about why she needs an MVA. Check her physical signs, like pulse and temperature, to see if she needs other medical care as well. Find out how long she has been pregnant. **MVA is only safe during the first 16 weeks (or 4 months) of a pregnancy.** That is 16 weeks after the woman's last monthly bleeding. After that, the pregnancy is too far along for MVA to work. Only try to do MVA after 16 weeks if the woman is in serious danger after incomplete abortion or miscarriage, and you have no other way to help her. See page 88 for methods to help you know how long a woman has been pregnant.

To be sure that a woman is less than 3 months pregnant, you should do a bimanual exam (see page 387) before doing an MVA.

Incomplete abortion

A woman with an incomplete miscarriage or abortion is in serious danger. The womb must be emptied right away. Look for these signs of infection or injury:

- severe pain in the lower belly
- heavy bleeding from the vagina
- fast pulse (over 100 beats a minute)
- high temperature (over 38°C or 100.4°F)
- low or dropping blood pressure

See pages 413 to 418 to help a woman with these signs, or take her to a medical center right away.

Getting ready for the MVA

Help the woman to be comfortable

Tell the woman what you will be doing. Answer any questions that she has.

You should find a private place to do the MVA where others are not watching, and be sure to keep everything about her care confidential (see page 7).

Preventing pain during MVA

MVA can be painful. There are some things you can do to reduce the pain:

- Always tell the woman what you are doing and encourage her to ask questions.
- Move smoothly and do not rush.
- Show the woman how to take slow, deep breaths. This can help her body relax. You can take slow deep breaths too! This will help you be gentle and careful.
- Give pain medicine.

Even when you are very gentle, there can be pain. Medicine to stop pain may cause unpleasant side effects, but offer it to women if you can get it. Women should not have to suffer pain unnecessarily.

And remember — pain medicine cannot replace gentle and respectful care.

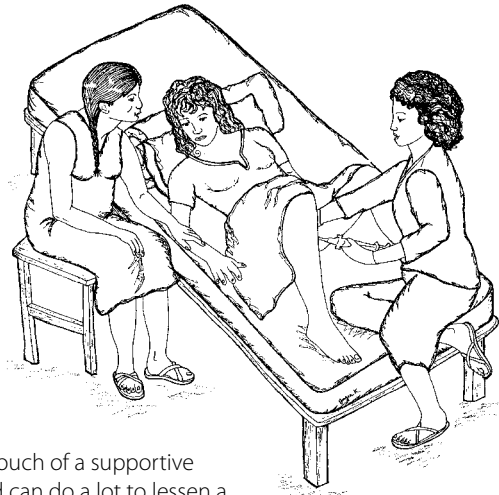

The touch of a supportive friend can do a lot to lessen a woman's pain.

There are 2 types of medicine to lessen pain from MVA. You can give pills by mouth and give an injection near the cervix to numb that part of the body. This is also the time to give medicines to prevent infection.



To prevent pain

- give 400 to 800 mg of ibuprofenby mouth, 30 minutes before you start the MVA

and

- see page 428 for instructions on giving an injection to numb the cervix

To prevent infection

- give 200 mg of doxycyclineby mouth

or

if the person is breastfeeding:

- give 500 mg of azithromycin.....by mouth

Prepare tools and supplies for doing MVA

There are several different devices used to do MVA. In this chapter, we explain how to use an MVA kit made by an organization named Ipas. (See page 503 to find out how to purchase MVA kits.)

MVA kits have 2 main parts:

One part is a 60 cc syringe with a wide opening that creates a vacuum to pull the contents of the womb out.

The other main part of the kit is a set of plastic tubes called cannulas. One end of the cannula will be attached to the syringe. The other end will be put inside the womb.

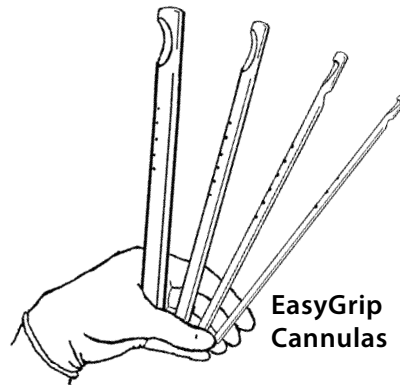
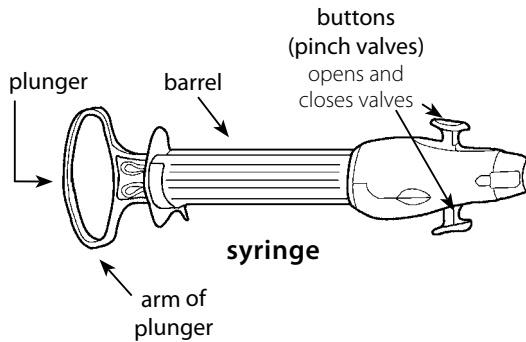

How the syringe works

When the buttons on the syringe are pushed in, the valve is opened and the contents of the womb are sucked through the cannula into the syringe.

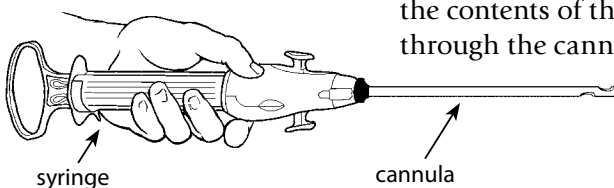

Taking care of the syringe

The syringe for MVA should be taken apart completely and all pieces carefully cleaned and sterilized after each use. While reassembling to use it again, lubricate the rubber ring at the bottom of the plunger of the syringe with a little silicone lubricant or even a little vegetable oil. Read the instructions that came with the syringe to learn how to care for it.

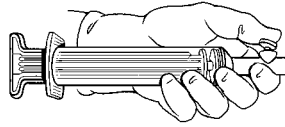

A 1-valve syringe

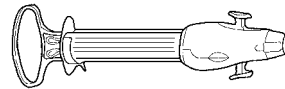

A 2-valve syringe

The *MVA plus* syringe

Note: Different MVA syringes are available that can be used up to 12 weeks. Some older, smaller syringes were good only for pregnancies up to 8 weeks. Follow the instructions carefully for the syringe you have.

Sterilize your tools

Sterilize all the tools that you will put inside the vagina or the womb (see page 59) and lay them out on a sterilized cloth, paper, or dish. You must wear sterile gloves any time you touch a sterile tool.

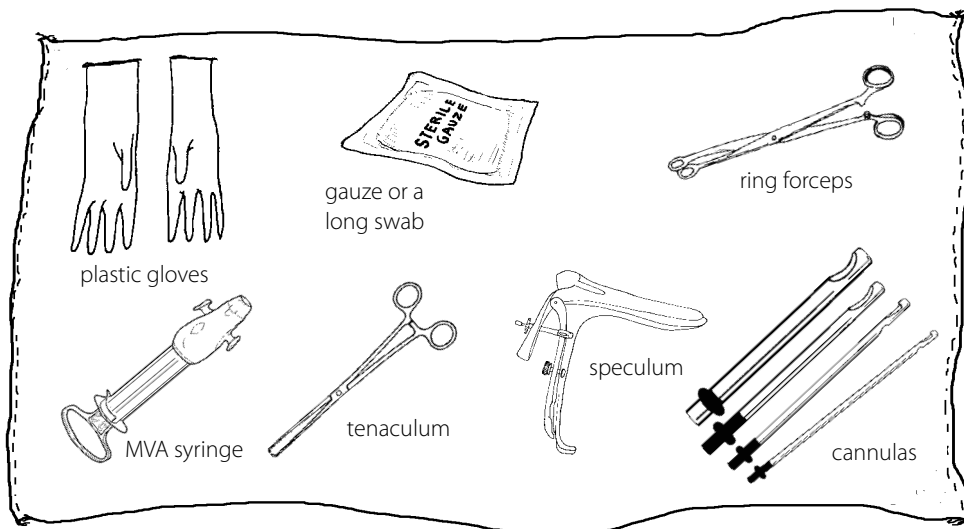

You will also need a small bowl of antiseptic like *Hibiclens* or betadine to clean the outside of the cervix. And be sure you have a good source of light.

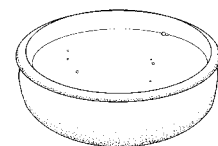

Doing the MVA

1. Create a vacuum in the syringe:

With the plunger all the way into the cylinder, close the valve by pushing the buttons inward and forward — the button will make a “click” sound and will stay stuck in place until you open it again.

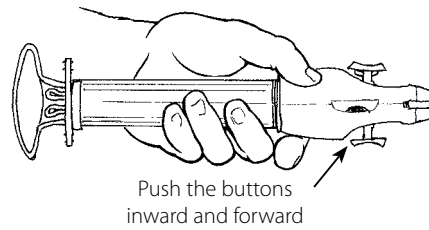

Hold the barrel of the syringe with one hand and pull the plunger back with the other hand, until the arms of the plunger snap outward at the end of the syringe barrel.

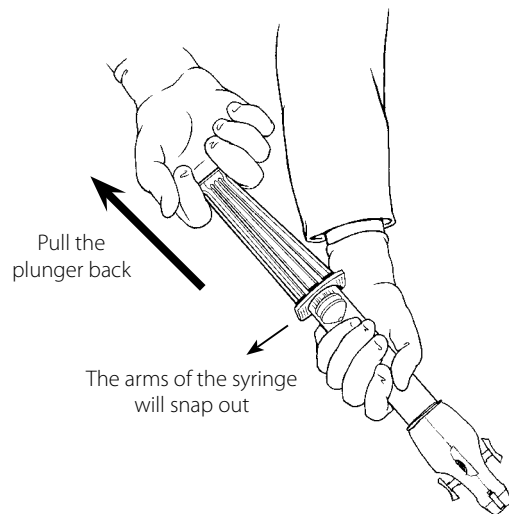

Check the arms of the plunger. They should both be out as far as they can go. With the arms snapped in this position, you should not be able to push the plunger back into the barrel.



WARNING! Never squeeze the arms of the plunger together or push the plunger into the barrel while doing an MVA. That would push the contents of the syringe back up into the woman’s womb. This could harm or even kill the woman.

2. Shine a light on the woman’s genitals so you can see well. You may need a helper to hold the light.

3. Wash your hands with soap and water for several minutes (see page 53). Let your hands dry in the air.

Put clean plastic gloves on your hands.

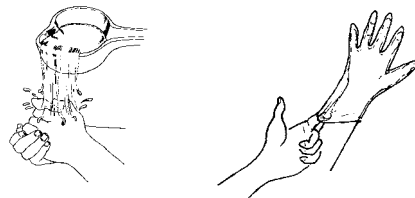

4. When the woman tells you she is ready, follow the steps on page 387 to do a bimanual exam. Feel the size of the womb. The womb should be the right size for the number of weeks the woman has told you that she was pregnant. If her womb is very big, she might have been pregnant for longer than she thinks. Do not do MVA for a woman who is more than 3 months pregnant, unless she is having serious problems from an incomplete abortion and you have no other way to help her.

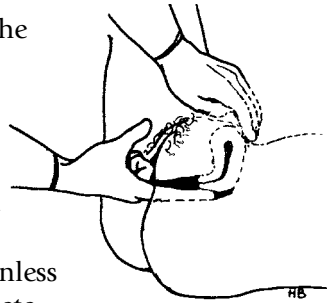

5. Take off your gloves, wash your hands, and put on new, sterile gloves. This will allow you to keep all the tools for the MVA sterile.
6. Gently insert a speculum (see page 377).



7. Dip a piece of sterile gauze held with the ring forceps, or a long swab, into antiseptic. Use the gauze or swab to wash the cervix.

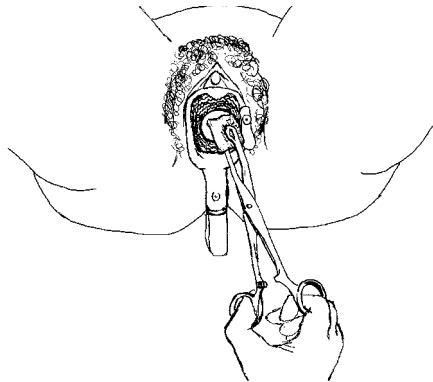

8. If you can give injections to numb the cervix, do so now (see box on page 428).
9. Ask the woman to breathe deeply and relax. When she is ready, grasp the cervix with a tenaculum or a ring forceps. Close the tenaculum and pull it a little to straighten the womb. This can be very uncomfortable for the woman, so be gentle and tell her what you are doing.

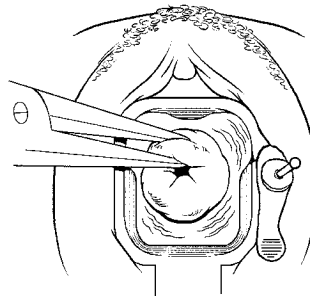
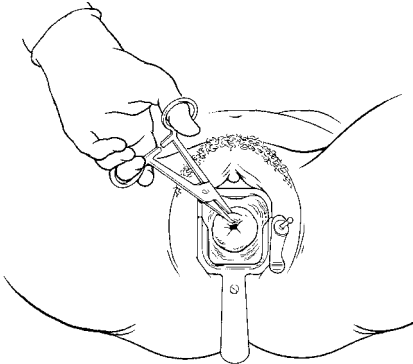

Injections to numb the cervix

You will need a sterilized 3 cm (1 inch) needle and 20 ml of 1% lidocaine or another local anesthetic with **no epinephrine** in it.

Before the injection, ask the woman if she has had this kind of anesthetic medicine before. Find out if she ever had a bad reaction to this medicine. If she has had a bad reaction, do not give the injections.

Follow the instructions on pages 345 to 349 to prepare and give an injection. For these injections, you will insert the needle about 1 centimeter under the skin and inject slowly as you pull the needle out.

After placing the speculum and using antiseptic to wash the cervix, inject 2 ml of lidocaine at the top of the cervix (12 o'clock) where you will later grasp with the tenaculum. Then grasp the cervix with the tenaculum, and use it to move the cervix a little to the side until you can see the place where the cervix (which is smooth) joins the vagina (which is more rough). Then give 4 injections of the rest of the lidocaine where the cervix joins the vagina, at 2, 4, 8 and 10 o'clock.

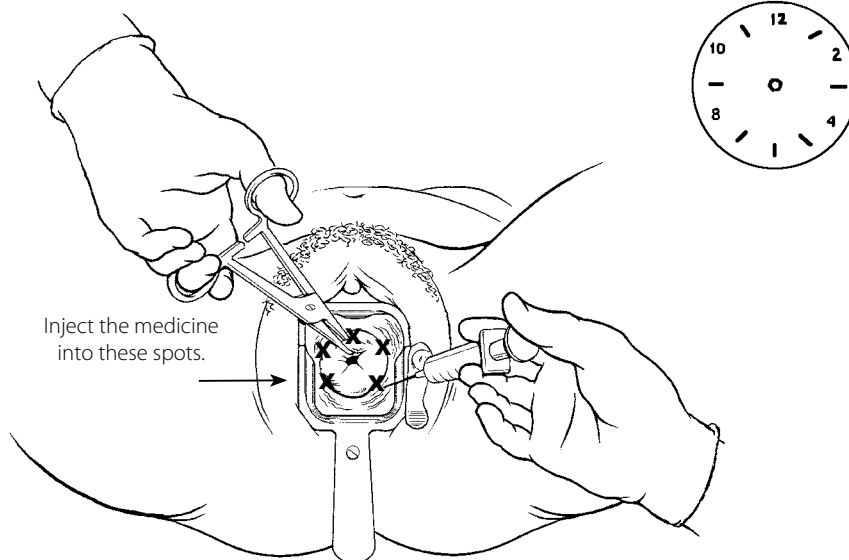
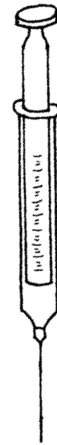

You can now begin the MVA. The woman may still feel cramping after the injection, but it will not hurt as much.

10. Choose a cannula. Cannulas come in many different sizes (the size may be printed on it). **The larger a woman's womb is, the larger a cannula you should use.** This chart gives you an idea of which cannula might work best:

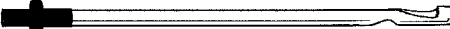
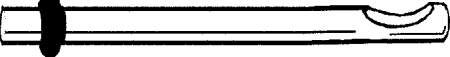
For a woman who is	
5 to 7 weeks pregnant.....use a 5 mm cannula (9 cm long womb)	
7 to 9 weeks pregnantuse a 6 mm cannula (10 cm long womb)	
9 to 12 weeks pregnant.....use a 7, 8, 9, 10, or 12 mm cannula (12 cm long womb)	

11. Some types of cannula need an adapter to fit onto some syringes. If you need an adapter, attach one now.

12. Tell the woman that you are ready to start. When she is ready, gently push the sterilized cannula through the opening in the cervix. Do not let the cannula touch anything — even the walls of the vagina — before it goes into the cervix. Sometimes the cervix is too tight to let a large cannula in. If this is the case, first insert a small cannula into the cervix, and then take it out and put in a larger cannula.

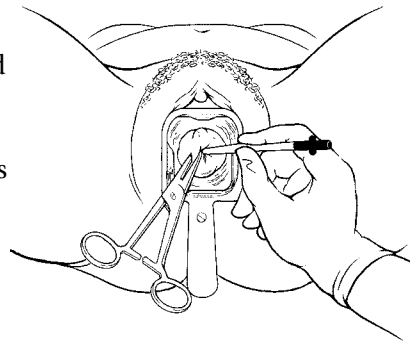

Try gently turning the cannula as it passes through the cervix. This will make it easier to insert.

As you insert a cannula, pay attention to the woman to make sure she is not in pain. Ask her to tell you if the procedure hurts. Sometimes the expression on a woman's face will tell you she is in pain even though she is not making any sounds.

If the woman is in pain, slow down. Moving slowly will help prevent injuries. Ask the woman to take deep breaths to help her relax and to help her cervix open.

13. Gently guide the cannula in until you feel it stop at the top of the womb. When you feel the top of the womb, pull the cannula back just a little. If you need to, you can let go of the tenaculum.

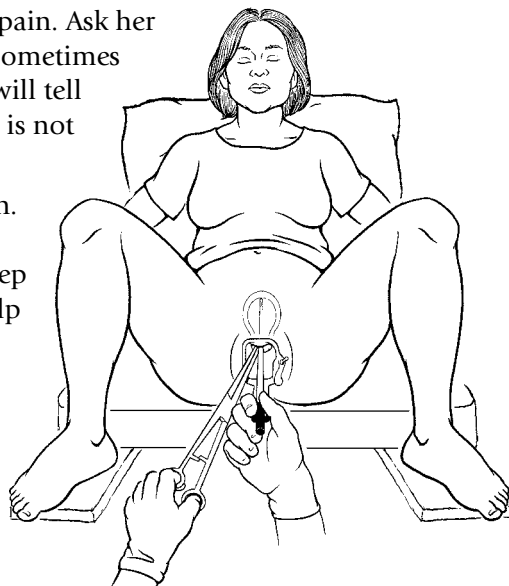

The vagus nerve

Sometimes when a cannula is put into a woman's womb, she feels lightheaded, dizzy, or nauseated. She may faint. This is usually because pressure was put on her vagus nerve.

The vagus nerve starts in the back of the brain inside the head and travels all the way down the back and then down each leg. This nerve passes close behind the womb, and when something like a cannula is put into the womb it may press on this nerve.

Signs of a vagal reaction:

- The woman may become sweaty, cold, or pale.
- Her pulse gets faster, and her blood pressure lowers.
- She feels faint, dizzy, or nauseated.

This feels uncomfortable for the woman, but it is not dangerous. Stop the MVA. Remove the cannula, tenaculum, and speculum. Help her move off of her back and onto her side, keep her warm and calm, and wait until the feeling passes. When she feels better, you can start the MVA again.

14. Hold the syringe with one hand and the cannula with the other. Attach the syringe to the cannula by pulling the cannula slightly back onto the syringe. Make sure you do not push the cannula forward into the womb. Pushing too far will injure the womb.

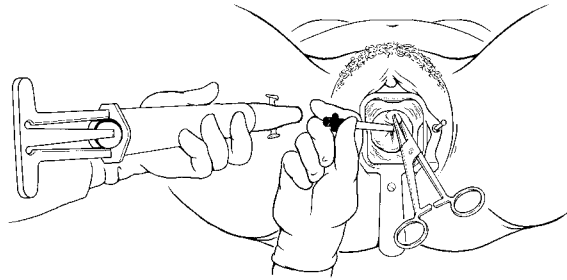

15. Pinch the buttons on the syringe toward yourself to open the valve. The button will make a clicking sound. Foamy and bubbly fluid and some blood and tissue from the pregnancy will flow from the womb into the syringe. Some blood may also come out into the vagina.

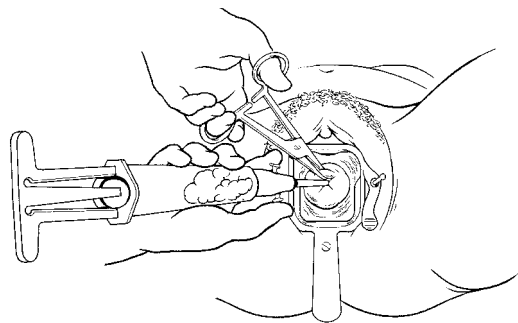

16. Empty the womb by slowly and gently moving the cannula in and out while you rotate the syringe.

Do not pull the tip of the cannula out of the womb.

If you pull the cannula tip out of the cervix, the vacuum will be broken. Even if you push the cannula back into the womb, it will not pull tissue anymore. The MVA will not be complete.

Do not push the cannula too far in or you could injure the womb.

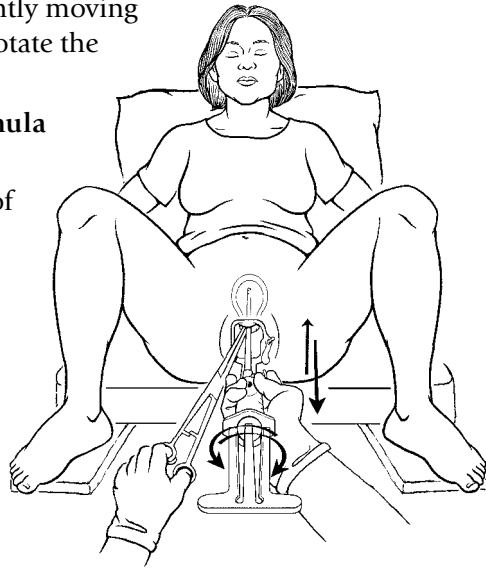

17. Keep moving and turning the syringe until the womb is empty. Usually, the womb empties within 5 minutes.

These are the signs that the womb is empty:

- There is only pinkish foam in the cannula.
- There is no more tissue in the cannula.
- When you touch the cannula tip to the inside of the womb, it feels rough and gritty.
- The womb tightens down and “grips” the cannula.

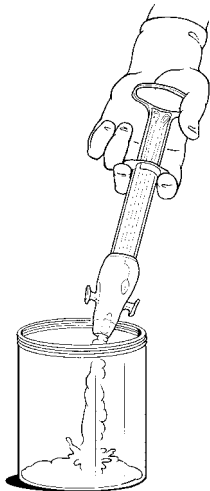

18. When the womb is empty, take the syringe off the cannula. Empty the syringe into a clear container, like a glass jar.

Now gently pull out the cannula, and then remove the tenaculum and take out the speculum.

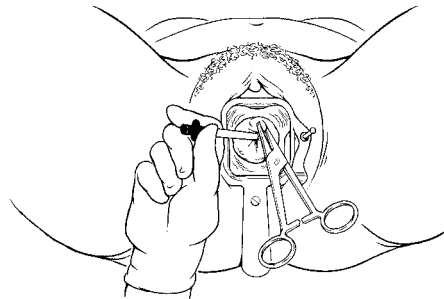

19. Look at the tissue from the womb to see if it is complete.

It is important to know if you have removed all the tissue, because if any is left inside the womb it can cause infection and bleeding.

Pour the tissue through a sieve or add some clean water to the jar it is in. What you see will depend on why the woman needed the MVA.

If the woman had an MVA to end a pregnancy or because she was bleeding from a miscarriage, you should see the complete pregnancy. After 4 weeks of pregnancy, there should be white or yellowish feathery tissue attached to a small, clear sac. If you do not see all this material, repeat the MVA.

If you are doing an MVA to empty the womb after an incomplete abortion or incomplete miscarriage, you might not see all of this tissue. Some of it may have already passed out of the womb. Take note of what you see anyway. If you did not see the complete pregnancy tissue when you did the MVA, and the woman has bleeding or signs of infection later, you should repeat the procedure.

20. Use the suggestions on page 67 to 69 to safely dispose of the bloody tissue.

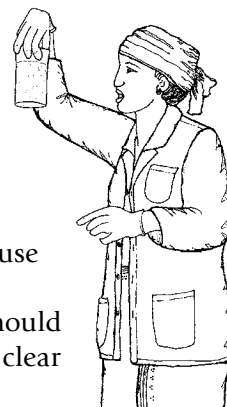

Problems with the MVA

There are some problems that can happen during MVA that will prevent the MVA from being complete. You must solve them to finish the MVA and to protect the woman from bleeding or becoming ill after the MVA.

The cannula comes out of the womb

If the tip of the cannula comes out of the womb after the valve has been opened, even if it comes out just a little, the vacuum will be lost. The syringe will not be able to remove any more tissue.

Solution:

1. Take the syringe off of the cannula.
2. Empty the syringe.
3. Put a new, sterilized cannula into the womb.

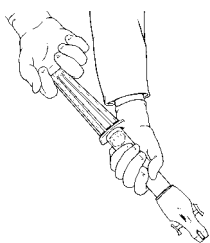
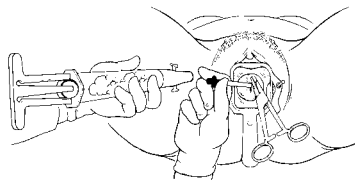

4. Make a new vacuum in the syringe — push the button down and forward to close the valve, and pull back the arms until they snap out at the end of the syringe barrel.
5. Gently attach the cannula to the syringe.
6. Open the valve by pushing the button toward yourself to continue emptying the womb.

The syringe is full

When the syringe is mostly full, it will not have enough vacuum to empty the rest of the tissue out of the womb.

Solution:

1. Take the syringe off of the cannula, leaving the cannula in the womb.
2. Empty the syringe.
3. Make a new vacuum in the syringe: Push the button down and in to close the valve, and pull back the arms until they snap out at the end of the syringe barrel.
4. Gently attach the cannula to the syringe again.
5. Open the valve by pushing the buttons toward yourself to continue emptying the womb.

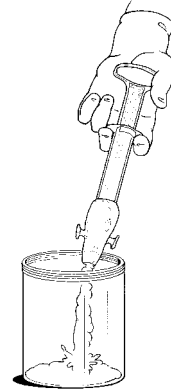

The cannula becomes clogged

Solution:

1. Remove the syringe and cannula from the womb and take the syringe off of the cannula.
2. Empty the syringe.
3. Put a new, sterilized cannula into the womb. **You may need a larger-sized cannula**

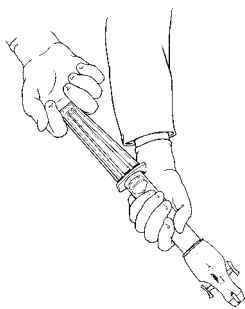
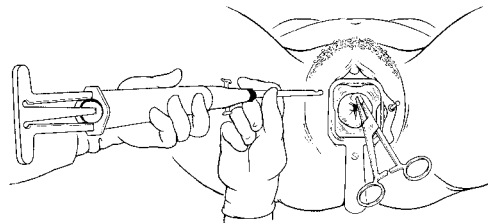

4. Make a new vacuum in the syringe: Push the button down and forward to close the valve, and pull back the arms until they snap out at the end of the syringe barrel.
5. Gently attach the cannula to the syringe.
6. Open the valve by pushing the buttons toward yourself to continue emptying the womb.

Sometimes there is a piece of tissue stuck in the cervix that continues to clog the cannula. You may be able to remove it with a pair of sterilized forceps.

The womb is too big to empty using MVA

Sometimes you may think that a woman's womb is small enough to do MVA, but after you start the MVA, you find out that it is too large. She may think she became pregnant later than she actually did. Or her womb may have felt smaller than it really was.

Solution:

If you start to do an MVA, but you cannot empty the womb all the way, first try using a larger cannula. But if you still cannot empty the womb, you must find someone else to empty her womb right away. Even if you must go to a distant hospital, you must get help. She is in serious danger.

You may also:

- give misoprostol to empty the womb (see page 412).
- watch for signs of infection (see page 413).



Problems that MVA can cause

When MVA is done correctly, problems rarely happen. But when there is a problem, the most common ones are:

- incomplete MVA (see page 411).
- infection (see page 413).
- injury to the womb (see page 417).

After the MVA

For the next day and night, check on the woman regularly to make sure she is OK. Check her temperature and pulse for signs of infection and check to see how much she is bleeding.

Tell the woman what to expect after the MVA. She should know to get help if she has any warning signs.

HEALTHY SIGNS

- Bleeding about as much as regular monthly bleeding for a few days to a week.
- Some cramping for 2 or 3 days.

WARNING SIGNS

- Bleeding that is more than her usual monthly bleeding — especially bright red blood or large clots.
- Bleeding for more than two weeks after the MVA.
- Bad-smelling discharge from the vagina.
- Womb that stays enlarged or that grows bigger after the MVA.
- Strong pain, increasing pain, or cramping or pain in the belly or pelvis for more than 3 or 4 days.
- Fever, chills, or feeling ill.
- Feeling weak or dizzy, or fainting.

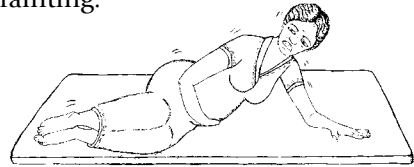

If the woman is bleeding more than a normal monthly bleeding, rub her womb every few hours (see page 224) to keep it hard and to push out any blood clots. Putting a bag of ice on her belly for 15 or 20 minutes may help too.

If she continues to bleed or has any other danger signs, get medical help.

Staying healthy after an MVA

Tell the woman what she should expect while her body heals. It is normal for her body to take a couple of weeks to feel like it did before she was pregnant. Tell her what warning signs to look for. And be sure the woman has a chance to talk about how she feels. Some women have fear, sadness, or other feelings after an MVA.

For the next few weeks, the woman should take care of her body so she can heal quickly and completely. She should avoid putting anything in her vagina and should not have vaginal sex until she stops bleeding.

Encourage the woman to drink plenty of liquids and to eat good, healthy foods. She should rest for a few days if possible.

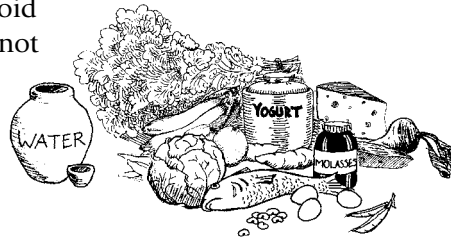
**Family planning**

Especially if a woman had an MVA to resolve a pregnancy she did not want, she might be ready to begin a family planning method. Always ask if a woman wants to know more about family planning. Tell her that it is possible to become pregnant as soon as a week after an MVA, and help her understand that she should use condoms or another method right away if she does not want to become pregnant. See Chapter 17 to help her find a family planning method that works for her.